

**ALÉSOIRS DE PRÉCISION
PRÄZISIONS-REIBAHLEN
ALESATORI DI PRECISIONE**

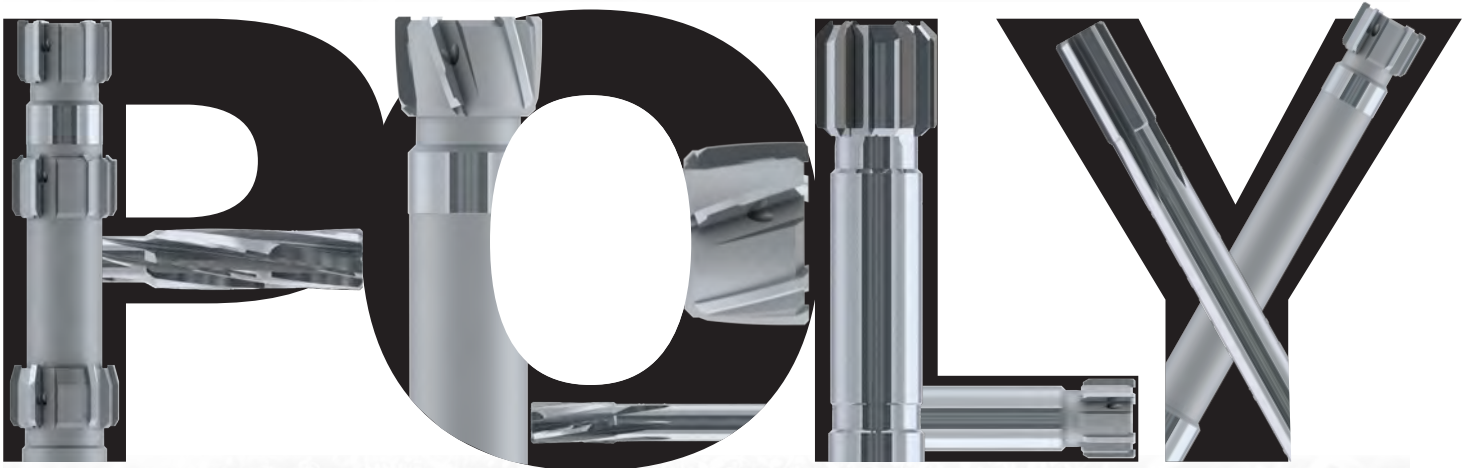

18 FR - DE - IT

swiss
made 
since
1946

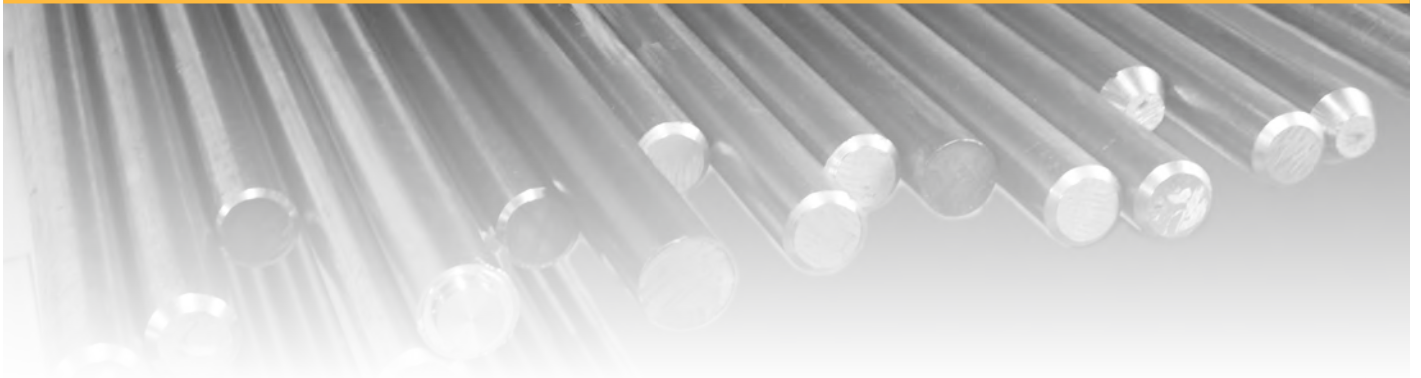

Enjoy Swiss Precision

www.dixipolytool.com

ALÉSOIRS EN CARBURE MONOBLOC & FIXES
VHM- & FEST-REIBAHLEN
ALESATORI FISSI IN METALLO DURO INTEGRALE &
BRASATI



9

ALÉSOIRS EXPANSIBLES
NACHSTELL-REIBAHLEN
ALESATORI ESPANDIBILI



31

TÊTES FIXES & EXPANSIBLES
FEST-KÖPFE & NACHSTELL-KÖPFE
TESTINE FISSE & ESPANDIBILI



41

PORTE-OUTILS DE COMPENSATION & PORTE-OUTILS
AUSGLEICHSHALTER & HALTER
MANDRINI DI COMPENSAZIONE & PORTAUTENSILI



51

CONDITIONS DE COUPE
SCHNITTDATEN
CONDIZIONI DI LAVORO



63

REGARNISSAGE / TECHNOLOGIE / GÉOMETRIE DE
COUPE
NEUBESTÜCKUNG / TECHNOLOGIE
/ ANSHNITT GEOMETRIE
RIGENERAZIONE / TECNOLOGIA / GEOMETRIA
IMBOCCO



69

ALÉSOIRS EN CARBURE MONOBLOC
 VHM-REIBAHLEN
 ALESATORI IN METALLO DURO INTEGRALE
 Ø 0.40 - Ø 12.02 mm

**DE STOCK
 AB LAGER
 A MAGAZZINO**



P. 10

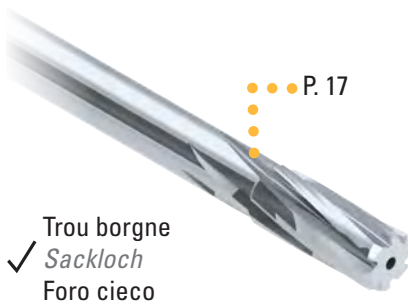

P. 17

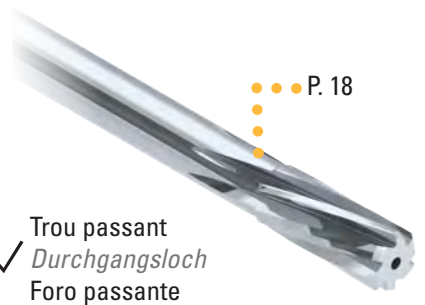

P. 18

ALÉSOIRS FIXES BRASÉS
 GELÖTETE FEST-REIBAHLEN
 ALESATORI FISSI BRASATI
 Ø 5.80 - Ø 130.00 mm

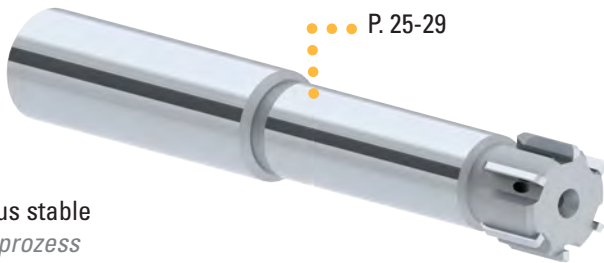

P. 25-29

ALÉSOIRS EXPANSIBLES BRASÉS
 GELÖTETE NACHSTELL-REIBAHLEN
 ALESATORI ESPANSIBILI BRASATI
 Ø 5.80 - Ø 55.00 mm

**DE STOCK
 AB LAGER
 A MAGAZZINO**

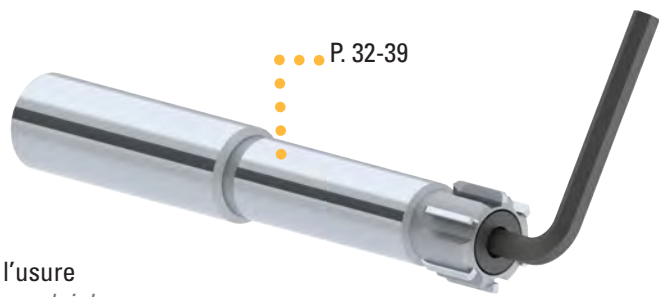

P. 32-39

PORTE-OUTIL + TÊTE (Ø 9.60 - Ø 55.00) + VIS
 HALTER + KOPF (Ø 9.60 - Ø 55.00) + SCHRAUBE
 PORTAUTENSILI + TESTA (Ø 9.60 - Ø 55.00) + VITE









GUIDE DE SÉLECTION EN FONCTION DU DIAMÈTRE
 AUSWAHLHILFE GEMÄSS DEM DURCHMESSER
 GUIDA ALLA SELEZIONE IN FUNZIONE DEL DIAMETRO

DE STOCK
 AB LAGER
 A MAGAZZINO



SUR DEMANDE
 AUF ANFRAGE
 A RICHIESTA



OUTILS WERKZEUGE UTENSILI	page Seite pagina	Ø 0.40	Ø 5.80	Ø 9.60	Ø 12.02	Ø 20.00	Ø 24.00	Ø 45.00	Ø 55.00	Ø 130.00
 ALÉSOIRS EN CARBURE MONOBLOC VHM-REIBAHLEN ALESATORI IN METALLO DURO INTEGRALE	10 - 24		DE STOCK	DE STOCK	DE STOCK	DE STOCK	DE STOCK	SUR DEMANDE		
 ALÉSOIRS FIXES BRASÉS GELÖTETE FEST-REIBAHLEN ALESATORI FISSI BRASATI	25 - 29			SUR DEMANDE	SUR DEMANDE	SUR DEMANDE	SUR DEMANDE	SUR DEMANDE	SUR DEMANDE	SUR DEMANDE
 ALÉSOIRS EXPANSIBLES BRASÉS GELÖTETE NACHSTELL-REIBAHLEN ALESATORI ESPANDIBILI BRASATI	32 - 39		DE STOCK	DE STOCK	DE STOCK	DE STOCK	DE STOCK	SUR DEMANDE		
 TÊTES FIXES BRASÉES GELÖTETE FEST-KÖPFE TESTINE FISSE BRASATE	42 - 43			SUR DEMANDE	SUR DEMANDE	SUR DEMANDE	SUR DEMANDE	SUR DEMANDE		
 TÊTES EXPANSIBLES BRASÉES GELÖTETE NACHSTELL-KÖPFE TESTE ESPANDIBILI BRASATE	44 - 45			SUR DEMANDE	SUR DEMANDE	SUR DEMANDE	SUR DEMANDE	SUR DEMANDE		
 TÊTES CARBURE MONOBLOC VHM-KÖPFE TESTINE FISSE IN METALLO DURO INTEGRALE	46 - 47			SUR DEMANDE	SUR DEMANDE	SUR DEMANDE	SUR DEMANDE	SUR DEMANDE		



SERVICE DE REGARNISSAGE
NEUBESTÜCKUNGSERIVCE
SERVIZIO DI RIGENERAZIONE

✓ Economique
✓ *Günstiger*
Economico

✓ Tous fabricants
✓ *Alle Mitbewerber*
Di qualsiasi marca



ALÉSOIRS SUR DEMANDE
REIBAHLEN AUF ANFRAGE
ALESATORI A RICHIESTA



ENVOYEZ VOTRE DEMANDE À *SENDEN SIE IHRE ANFRAGE AN* INVIALE LA VOSTRA RICHIESTA A
dixipoly@dixi.ch



SERVICE & SUPPORT TECHNIQUE
DIENST & SERVICE & TECHNISCHER SUPPORT
SERVIZIO & SUPPORTO TECNICO

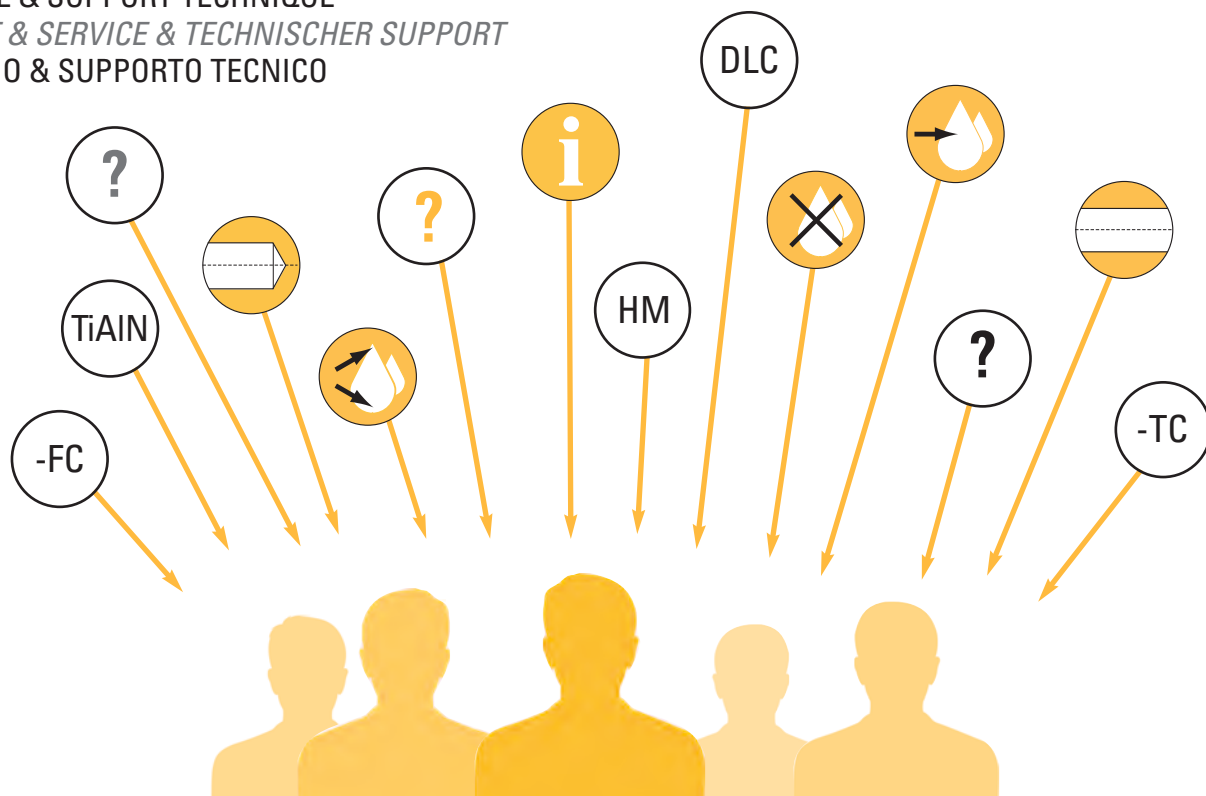

ENVOYEZ VOTRE DEMANDE À *SENDEN SIE IHRE ANFRAGE AN* INVIATE LA VOSTRA RICHIESTA A
dixipoly@dixi.ch

FILIALES & AGENTS
TOCHTERGESELLSCHAFTEN & AGENTEN
FILIALI & AGENZIE

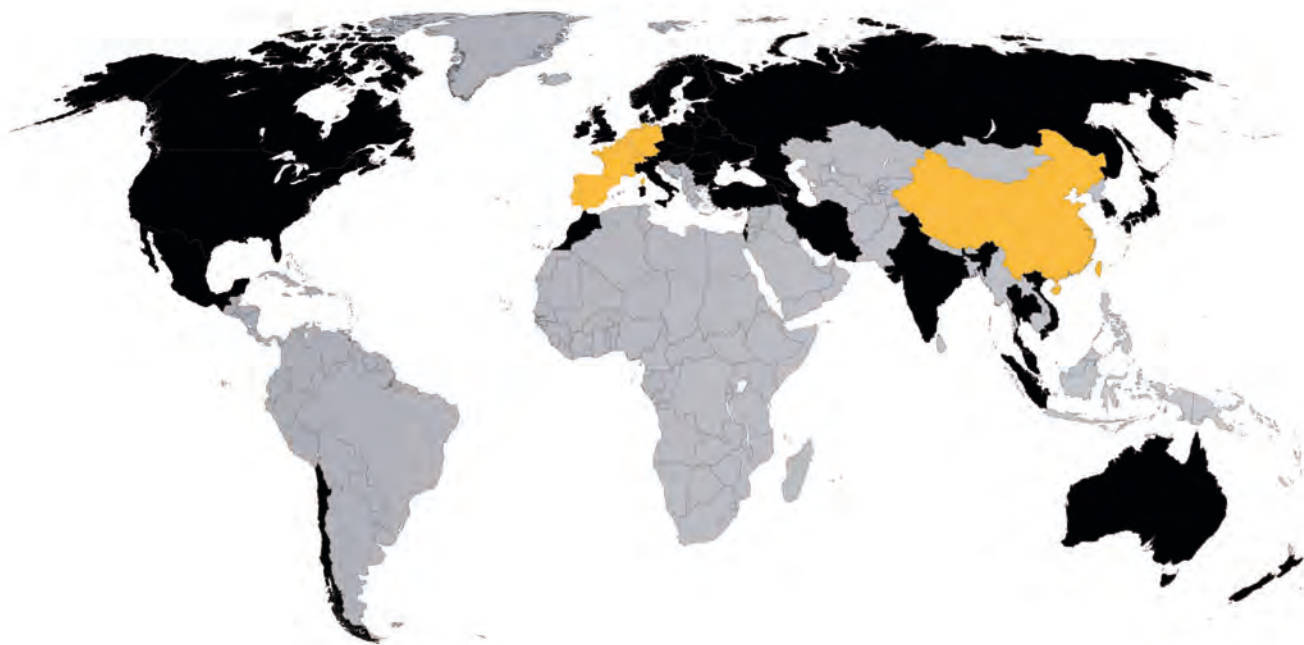

5 filiales
Tochtergesellschaften
filiali

40 pays représentants
Vertreter Länder
paesi rappresentanti

75 années d'expérience
Jahre Erfahrung
anni di esperienza

CHAMPS D'APPLICATION, MATIÈRES, DÉSIGNATION DIN
 ANWENDUNGSBEREICHE, WERKSTOFFE, DIN BEZEICHNUNG
 CAMPI DI APPLICAZIONE, MATERIALI, CLASSIFICAZIONE DIN



Matières à usiner























































Zu bearbeitender Werkstoff

Materiale da lavorare

		DIN	W. Nr.	Rm	HB / HRC
P	Acier non allié / faiblement allié <i>Niedrig leg. / unleg. Stahl</i> Acciaio non legato / leggermente legato	St37-2 / S235JR 9SMn28 / 11SMn30 St52-2 / E295 9SMnPb28 / 11SMnPb30	1.0037 1.0715 1.0050 1.0718	< 600 N/mm ²	
P	Acier non allié / faiblement allié <i>Niedrig leg. / unleg. Stahl</i> Acciaio non legato / leggermente legato	42CrMo4 CK60 / C60E	1.7225 1.1221	600 – 1500 N/mm ²	
P	Acier fortement allié <i>Hochlegierter Stahl</i> Acciaio fortemente legato	X6CrMo4 / 6CrMo15-5 X165Cr-MoV12	1.2341 1.2601	700 – 1500 N/mm ²	
M	Acier inoxydable <i>Rostfreier Stahl</i> Acciaio inossidabili	X2CrNi189 / X2CrNi19-11 Mo1810 / X5CrNiMo17-12-2 X2CrNiMo18-14-3 / 316L X8CrNb17 / X3CrNb17	1.4306 1.4401 1.4435 1.4511	400 – 700 N/mm ²	
M	Acier inox. DUPLEX, acier austénitique inox. sans nickel <i>DUPLEX rostfreier Stahl</i> Acciaio inox DUPLEX, acciaio inox austenitico senza Ni	X10CrAlSi7 X8CrS-38-18	1.4713 1.4862	> 800 N/mm ²	
H	Acier trempé <i>Gehärtete Stähle</i> Acciaio temprato			> 1500 N/mm ²	45 - 65 HRC
K	Fonte grise <i>Grauguss</i> Ghisa grigia	GG-25 / EN-GJL-250 GG-35 / EN-GJL-350	0.6025 0.6035		< 250 HB
K	Fonte grise alliée <i>Leg. Grauguss</i> Lega di ghisa grigia	GG-NiCr202 / GJL-NiCr20-2	0.6660		> 250 HB
K	Fonte à graphite sphéroïdal ferritique / perlitique <i>Sphäroguss ferritisch / perlitisch</i> Ghisa ferritica sferoidale / perlitica	GGG-40 / EN-GJS-400-15 GGG-50 / GGG-55 GTW-55	0.7040 0.7050 0.8055		< 600 HB
K	Fonte à graphite sphéroïdal ferritique / Fonte malléable <i>Sphäroguss ferritisch / Temperguss</i> Ghisa perlitica sferoidale / Ghisa malleabile	GGG-60 / EN-GJS-600-3 GTS-65	0.7060 0.8165		> 600 HB
K	Alliages fonte sphéroïdale <i>Leg. Sphäroguss</i> Leghe di ghisa sferoidale	GGG NiCr20-2 GGV Ti <0.2 GGV Ti >0.2	0.7661		
S	Super alliages / Acier inox. réfractaire <i>Sonderlegierungen / Warmfester rostfreier Stahl</i> Leghe speciali / Acciaio inox refrattario	Inconel Nimonic Hastelloy		> 1500 N/mm ²	
S	Titane, alliage de titane <i>Titan, Titanlegierung</i> Titanio e relative leghe	TiAl55n2	3.7114		
N	Alliage de cuivre (laiton - bronze) <i>Kupfer-Legierung (Messing - Bronze)</i> Rame e relative leghe (ottone - bronzo)	CuZn36Pb3 G-CuPb15Sn	2.1182 2.1182		
N	Alliage de cuivre / Bronze à l'aluminium <i>Kupfer-Legierung / Aluminium-Bronze</i> Rame e lega / Bronzo con alluminio	CuZn40Al1 E-Cu57	2.0550 2.0060		
N	Alliage d'aluminium <8 % Si / Alliage de magnesium <i>Aluminium-Knetlegierung <8 % Si / Magnesiumlegierungen</i> Leghe d'alluminio <8 % Si / Leghe di magnesio	G-AlMg5	3.3561		
N	Alliage d'aluminium >8 % Si <i>Aluminium-Knetlegierung >8 % Si</i> Leghe d'alluminio >8 % Si	G-AISi9Mg G-AISi10Mg	3.2373 3.2381		



HM Carbure **x** Non applicable  Bien  Excellent
 Hartmetall Nicht anwendbar Gut Ausgezeichnet
 Metallo duro Non applicabile Bene Eccellente

HM	HM + TiAlN	HM + POLY-CUT	HM + C-TOP	HM + DLC	CERMET
				x	
				x	
				x	
				x	x
				x	x
				x	x
				x	
				x	
				x	
				x	
				x	
				x	x
				x	x
					
					
					
					



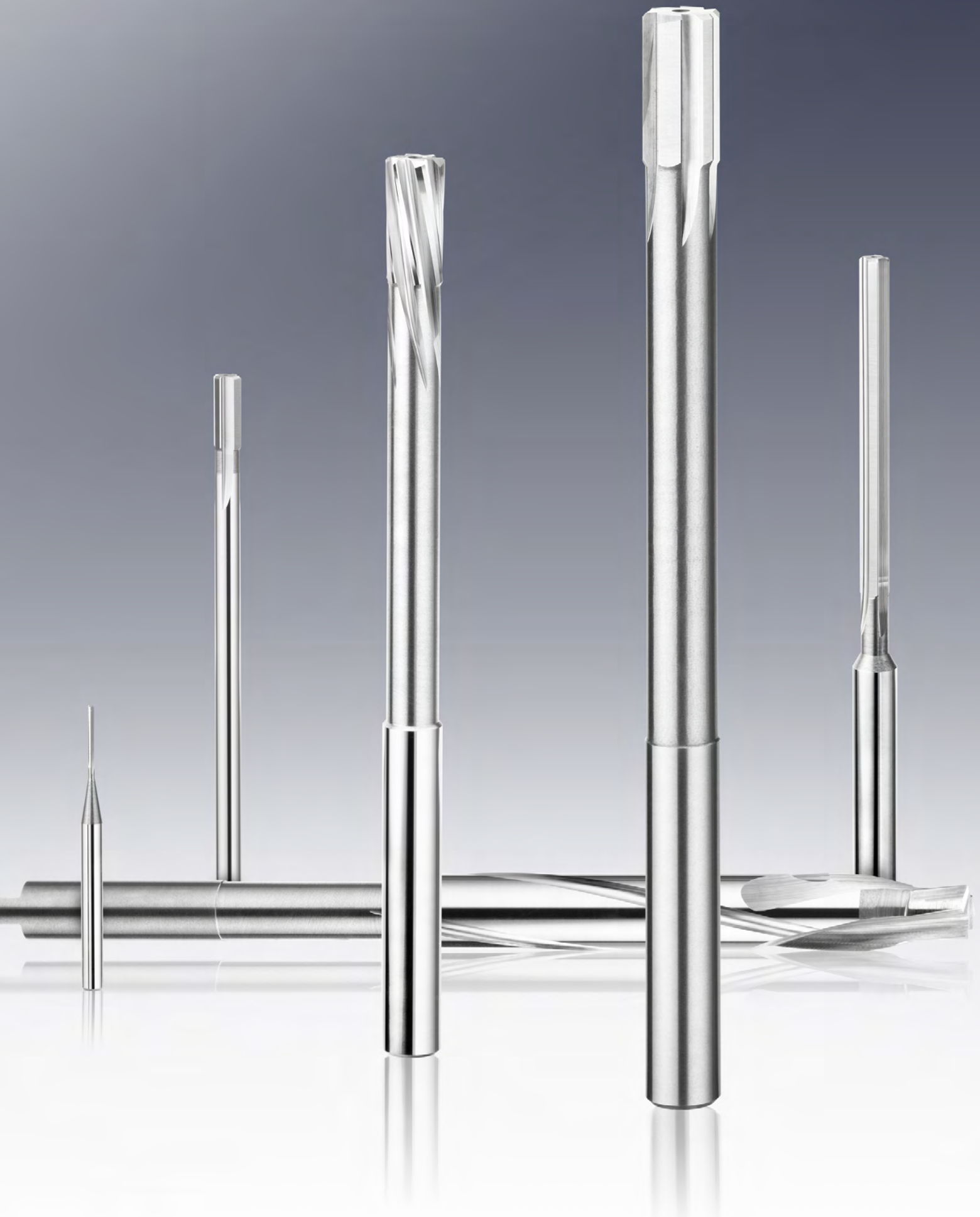

ALÉSOIRS EN CARBURE MONOBLOC & FIXES
VHM- & FEST-REIBAHLEN
 ALESATORI FISSI IN METALLO DURO INTEGRALE & BRASATI



ALÉSOIRS EN CARBURE MONOBLOC, DENTURE DROITE
VHM-REIBAHLEN, GERADE VERZAHNUNG
 ALESATORI IN METALLO DURO INTEGRALE, TAGLIENTI DIRITTI **10**

DE STOCK
 AB LAGER
 A MAGAZZINO



ALÉSOIRS EN CARBURE MONOBLOC, HÉLICE À DROITE
VHM-REIBAHLEN, RECHTS SPIRALISIERT
 ALESATORI IN METALLO DURO INTEGRALE, ELICA DESTRA **17**

DE STOCK
 AB LAGER
 A MAGAZZINO



ALÉSOIRS EN CARBURE MONOBLOC, HÉLICE À GAUCHE
VHM-REIBAHLEN, LINKS SPIRALISIERT
 ALESATORI IN METALLO DURO INTEGRALE, ELICA SINISTRA **18**

DE STOCK
 AB LAGER
 A MAGAZZINO



ALÉSOIRS FIXES COURTS BRASÉS
GELÖTETE KURZE FEST-REIBAHLEN
 ALESATORI FISSI CORTI BRASATI **25**



ALÉSOIRS FIXES COURTS BRASÉS, DENTURE À GAUCHE
GELÖTETE KURZE FESTREIBAHLEN, LINKS SPIRALISIERT
 ALESATORI FISSI CORTI BRASATI, DENTATURA SINISTRA **25**



ALÉSOIRS FIXES LONGS BRASÉS
GELÖTETE LANGE FEST-REIBAHLEN
 ALESATORI FISSI LUNGHI BRASATI **26**



ALÉSOIRS FIXES COURTS BRASÉS POUR MATIÈRES > 45 HRC
GELÖTETE KURZE FEST-REIBAHLEN FÜR WERKSTOFFE > 45 HRC
 ALESATORI FISSI CORTI BRASATI PER MATERIALI > 45 HRC **27**



ALÉSOIRS FIXES LONGS BRASÉS POUR MATIÈRES > 45 HRC
GELÖTETE LANGE FEST-REIBAHLEN FÜR WERKSTOFFE > 45 HRC
 ALESATORI FISSI LUNGHI BRASATI PER MATERIALI > 45 HRC **28**

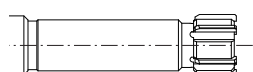

ALÉSOIRS FIXES BRASÉS SUR DEMANDE
GELÖTETE FEST-REIBAHLEN AUF ANFRAGE
 ALESATORI FISSI BRASATI A RICHIESTA **29**

POLY 4001 - 4001-TC

ALÉSOIRS CARBURE MONOBLOC, DENTURE DROITE
 VHM-REIBAHLEN, GERADE VERZÄHNUNG
 ALESATORI IN METALLO DURO INTEGRALE, TAGLIENTI DIRITTI



P. 64



> Ø 2.98

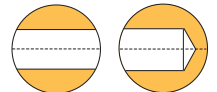

**DE STOCK
 AB LAGER
 A MAGAZZINO**

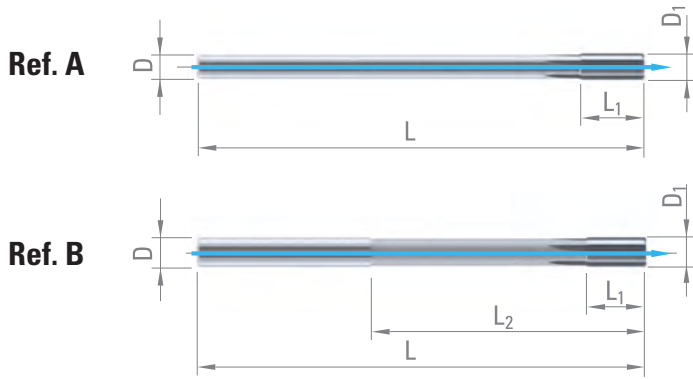

D nom. H7	D ₁ ± 1.5µm	L ₁	L ₂	D _{h5}	L	Z	Ref.	HM
0.40	(0.407)	3	5	3	38	3	B	959801
0.41	(0.417)	3	5	3	38	3	B	964623
0.42	(0.427)	3	5	3	38	3	B	959802
0.43	(0.437)	3	5	3	38	3	B	978100
0.44	(0.447)	3	5	3	38	3	B	959803
0.45	(0.457)	3	5	3	38	3	B	954360
0.46	(0.467)	3	5	3	38	3	B	959804
0.47	(0.477)	3	5	3	38	3	B	963057
0.48	(0.487)	3	5	3	38	3	B	959805
0.49	(0.497)	3	5	3	38	3	B	954359
0.50	(0.507)	3	5	3	38	3	B	959662
0.51	(0.517)	4	6	3	38	3	B	200007
0.52	(0.527)	4	6	3	38	3	B	200000
0.53	(0.537)	4	6	3	38	3	B	200004
0.54	(0.547)	4	6	3	38	3	B	200005
0.55	(0.557)	4	6	3	38	3	B	200001
0.56	(0.567)	4	6	3	38	3	B	966312
0.57	(0.577)	4	6	3	38	3	B	326970
0.58	(0.587)	4	6	3	38	3	B	200003
0.59	(0.597)	4	6	3	38	3	B	200006
0.60	(0.607)	4	6	3	38	3	B	200002
0.61	(0.617)	4	7	3	38	3	B	964889
0.62	(0.627)	4	7	3	38	3	B	200010
0.63	(0.637)	4	7	3	38	3	B	965815
0.64	(0.647)	4	7	3	38	3	B	200015
0.65	(0.657)	4	7	3	38	3	B	200008
0.66	(0.667)	4	7	3	38	3	B	200012
0.67	(0.677)	4	7	3	38	3	B	200013
0.68	(0.687)	4	7	3	38	3	B	200011
0.69	(0.697)	4	7	3	38	3	B	200014
0.70	(0.707)	4	7	3	38	3	B	200009
0.71	(0.717)	4	8	3	38	3	B	955902
0.72	(0.727)	4	8	3	38	3	B	200018
0.73	(0.737)	4	8	3	38	3	B	959571
0.74	(0.747)	4	8	3	38	3	B	200022
0.75	(0.757)	4	8	3	38	3	B	200016
0.76	(0.767)	4	8	3	38	3	B	961872
0.77	(0.777)	4	8	3	38	3	B	200020
0.78	(0.787)	4	8	3	38	3	B	200019
0.79	(0.797)	4	8	3	38	3	B	200021
0.80	(0.807)	4	8	3	38	3	B	200017

D nom. H7	D ₁ ± 1.5µm	L ₁	L ₂	D _{h5}	L	Z	Ref.	HM
0.81	(0.817)	5	9	3	38	3	B	964624
0.82	(0.827)	5	9	3	38	3	B	200025
0.83	(0.837)	5	9	3	38	3	B	200029
0.84	(0.847)	5	9	3	38	3	B	200028
0.85	(0.857)	5	9	3	38	3	B	200023
0.86	(0.867)	5	9	3	38	3	B	200030
0.87	(0.877)	5	9	3	38	3	B	200031
0.88	(0.887)	5	9	3	38	3	B	200026
0.89	(0.897)	5	9	3	38	3	B	200027
0.90	(0.907)	5	9	3	38	3	B	200024
0.91	(0.917)	5	10	3	38	3	B	200039
0.92	(0.927)	5	10	3	38	3	B	200035
0.93	(0.937)	5	10	3	38	3	B	960023
0.94	(0.947)	5	10	3	38	3	B	963188
0.95	(0.957)	5	10	3	38	3	B	200034
0.96	(0.967)	5	10	3	38	3	B	200036
0.97	(0.977)	5	10	3	38	3	B	200037
0.98	(0.987)	5	10	3	38	3	B	200032
0.99	(0.997)	5	10	3	38	3	B	200033
1.00	(1.007)	5	10	3	38	3	B	200038
1.01	(1.017)	5	11	3	38	3	B	959800
1.02	(1.027)	5	11	3	38	3	B	200040
1.03	(1.037)	5	11	3	38	3	B	966908
1.04	(1.047)	5	11	3	38	3	B	962626
1.05	(1.057)	5	11	3	38	3	B	200041
1.06	(1.067)	5	11	3	38	3	B	966799
1.07	(1.077)	5	11	3	38	3	B	968047
1.08	(1.087)	5	11	3	38	3	B	200042
1.09	(1.097)	5	12	3	38	3	B	955685
1.10	(1.107)	5	12	3	38	3	B	200045
1.11	(1.117)	5	12	3	38	3	B	951529
1.12	(1.127)	5	12	3	38	3	B	951598
1.13	(1.137)	5	12	3	38	3	B	968503
1.14	(1.147)	5	12	3	38	3	B	968504
1.15	(1.157)	5	12	3	38	3	B	200043
1.16	(1.167)	5	12	3	38	3	B	967147
1.17	(1.177)	5	12	3	38	3	B	956647
1.18	(1.187)	5	12	3	38	3	B	67307
1.19	(1.197)	5	12	3	38	3	B	960753
1.20	(1.207)	5	12	3	38	3	B	200044
1.21	(1.217)	6	13	3	38	3	B	67308

Tout Ø avec tolérance ±2µm livrable sur demande via notre service rapide
 Alle Ø mit Toleranz ±2µm lieferbar durch unseren Express-Service
 Ogni Ø con tolleranza ±2µm consegnabili tramite nostro servizio rapido

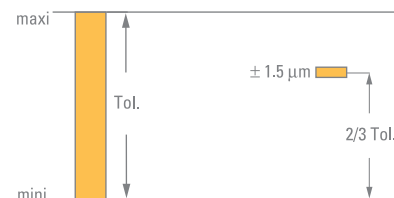

P. 73



POLY 4001 - 4001-TC



P. 64



> Ø 2.98

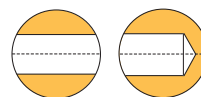

Ref. A



Ref. B

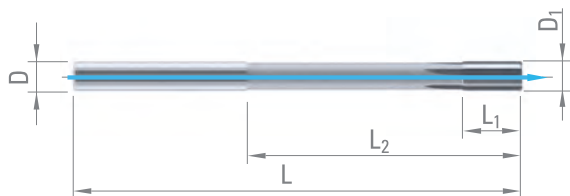

**DE STOCK
AB LAGER
A MAGAZZINO**

D nom. D₁ L₁ L₂ D_{h5} L Z Ref. HM
H7 ± 1.5µm

1.22	(1.227)	6	13	3	38	3	B	968605
1.23	(1.237)	6	13	3	38	3	B	968606
1.24	(1.247)	6	13	3	38	3	B	968607
1.25	(1.257)	6	13	3	38	3	B	200046
1.26	(1.267)	6	13	3	38	3	B	968608
1.27	(1.277)	6	13	3	38	3	B	964024
1.28	(1.287)	6	13	3	38	3	B	200048
1.29	(1.297)	6	13	3	38	3	B	950915
1.30	(1.307)	6	13	3	38	3	B	200047
1.31	(1.317)	6	13	3	38	3	B	959472
1.32	(1.327)	6	13	3	38	3	B	961369
1.33	(1.337)	6	13	3	38	3	B	961963
1.34	(1.347)	6	13	3	38	3	B	326971
1.35	(1.357)	6	13	3	38	3	B	200049
1.36	(1.367)	6	13	3	38	3	B	968242
1.37	(1.377)	6	13	3	38	3	B	960591
1.38	(1.387)	6	13	3	38	3	B	966541
1.39	(1.397)	6	13	3	38	3	B	960202
1.40	(1.407)	6	13	3	38	3	B	200050
1.41	(1.417)	7	15	3	38	3	B	957425
1.42	(1.427)	7	15	3	38	3	B	955757
1.43	(1.437)	7	15	3	38	3	B	955746
1.44	(1.447)	7	15	3	38	3	B	961345
1.45	(1.457)	7	15	3	38	3	B	200053
1.46	(1.467)	7	15	3	38	3	B	66791
1.47	(1.477)	7	15	3	38	3	B	961456
1.48	(1.487)	7	15	3	38	3	B	200051
1.49	(1.497)	7	15	3	38	3	B	200052
1.50	(1.507)	7	15	3	38	3	B	200054
1.51	(1.517)	7	15	3	50	3	B	200104
1.52	(1.527)	7	15	3	50	3	B	200105
1.53	(1.537)	7	15	3	50	3	B	960836
1.54	(1.547)	7	15	3	50	3	B	63795
1.55	(1.557)	7	15	3	50	3	B	200125
1.56	(1.567)	7	15	3	50	3	B	973910
1.57	(1.577)	7	15	3	50	3	B	963006
1.58	(1.587)	7	15	3	50	3	B	961472
1.59	(1.597)	7	15	3	50	3	B	959620
1.60	(1.607)	7	15	3	50	3	B	200111
1.61	(1.617)	7	16	3	50	3	B	59391
1.62	(1.627)	7	16	3	50	3	B	955366
1.63	(1.637)	7	16	3	50	3	B	326972
1.64	(1.647)	7	16	3	50	3	B	326973
1.65	(1.657)	7	16	3	50	3	B	200124
1.66	(1.667)	7	16	3	50	3	B	991141
1.67	(1.677)	7	16	3	50	3	B	965451
1.68	(1.687)	7	16	3	50	3	B	326974

D nom. D₁ L₁ L₂ D_{h5} L Z Ref. HM
H7 ± 1.5µm

1.69	(1.697)	7	16	3	50	3	B	952172
1.70	(1.707)	7	16	3	50	3	B	200126
1.71	(1.717)	7	17	3	50	3	B	66359
1.72	(1.727)	7	17	3	50	3	B	959573
1.73	(1.737)	7	17	3	50	3	B	326975
1.74	(1.747)	7	17	3	50	3	B	968498
1.75	(1.757)	7	17	3	50	3	B	200127
1.76	(1.767)	7	17	3	50	3	B	974605
1.77	(1.777)	7	17	3	50	3	B	961458
1.78	(1.787)	7	17	3	50	3	B	63459
1.79	(1.797)	7	17	3	50	3	B	200146
1.80	(1.807)	7	17	3	50	3	B	200112
1.81	(1.817)	8	17	3	50	3	B	962183
1.82	(1.827)	8	17	3	50	3	B	960953
1.83	(1.837)	8	17	3	50	3	B	951867
1.84	(1.847)	8	17	3	50	3	B	326976
1.85	(1.857)	8	17	3	50	3	B	200113
1.86	(1.867)	8	17	3	50	3	B	964274
1.87	(1.877)	8	17	3	50	3	B	326977
1.88	(1.887)	8	17	3	50	3	B	954731
1.89	(1.897)	8	17	3	50	3	B	200137
1.90	(1.907)	8	17	3	50	3	B	200114
1.91	(1.917)	8	18	3	50	3	B	982028
1.92	(1.927)	8	18	3	50	3	B	326978
1.93	(1.937)	8	18	3	50	3	B	326979
1.94	(1.947)	8	18	3	50	3	B	67301
1.95	(1.957)	8	18	3	50	3	B	200115
1.96	(1.967)	8	18	3	50	3	B	200145
1.97	(1.977)	8	18	3	50	3	B	200106
1.98	(1.987)	8	18	3	50	3	B	200107
1.99	(1.997)	8	18	3	50	3	B	200108
2.00	(2.007)	8	18	3	50	3	B	200102
2.01	(2.017)	8	18	3	50	3	B	200109
2.02	(2.027)	8	18	3	50	3	B	200110
2.03	(2.037)	8	18	3	50	3	B	63271
2.04	(2.047)	8	18	3	50	3	B	200147
2.05	(2.057)	8	18	3	50	3	B	200121
2.06	(2.067)	8	18	3	50	3	B	954744
2.07	(2.077)	8	18	3	50	3	B	63796
2.08	(2.087)	8	18	3	50	3	B	57717
2.09	(2.097)	8	18	3	50	3	B	957058
2.10	(2.107)	8	18	3	50	3	B	200144
2.11	(2.117)	8	18	3	50	3	B	952428
2.12	(2.127)	8	18	3	50	3	B	952429
2.13	(2.137)	8	18	3	50	3	B	967590
2.14	(2.147)	8	18	3	50	3	B	968815
2.15	(2.157)	8	18	3	50	3	B	200120



POLY 4001 - 4001-TC



P. 64



> Ø 2.98

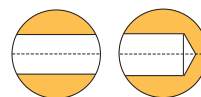

Ref. A



Ref. B

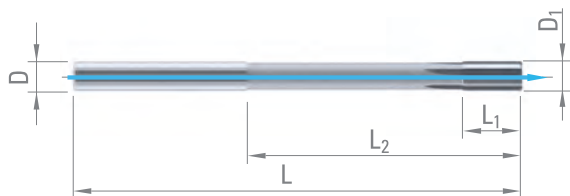

**DE STOCK
AB LAGER
A MAGAZZINO**

D nom. H7	D ₁ ± 1.5µm	L ₁	L ₂	D _{h5}	L	Z	Ref.	HM
2.16	(2.167)	8	18	3	50	3	B	968156
2.17	(2.177)	8	18	3	50	3	B	959096
2.18	(2.187)	8	18	3	50	3	B	968449
2.19	(2.197)	8	18	3	50	3	B	952213
2.20	(2.207)	8	18	3	50	3	B	200139
2.21	(2.217)	8	18	3	50	3	B	968816
2.22	(2.227)	8	18	3	50	3	B	953362
2.23	(2.237)	8	18	3	50	3	B	326980
2.24	(2.247)	8	18	3	50	3	B	326981
2.25	(2.257)	8	18	3	50	3	B	200119
2.26	(2.267)	8	18	3	50	3	B	326982
2.27	(2.277)	8	18	3	50	3	B	956015
2.28	(2.287)	8	18	3	50	3	B	326983
2.29	(2.297)	8	18	3	50	3	B	985826
2.30	(2.307)	8	18	3	50	3	B	200131
2.31	(2.317)	10	20	3	50	3	B	951944
2.32	(2.327)	10	20	3	50	3	B	200135
2.33	(2.337)	10	20	3	50	3	B	957326
2.34	(2.347)	10	20	3	50	3	B	956298
2.35	(2.357)	10	20	3	50	3	B	200130
2.36	(2.367)	10	20	3	50	3	B	955027
2.37	(2.377)	10	20	3	50	3	B	958068
2.38	(2.387)	10	20	3	50	3	B	962361
2.39	(2.397)	10	20	3	50	3	B	965907
2.40	(2.407)	10	20	3	50	3	B	200129
2.41	(2.417)	10	20	3	50	3	B	950038
2.42	(2.427)	10	20	3	50	3	B	950039
2.43	(2.437)	10	20	3	50	3	B	955020
2.44	(2.447)	10	20	3	50	3	B	962239
2.45	(2.457)	10	20	3	50	3	B	200128
2.46	(2.467)	10	20	3	50	3	B	326984
2.47	(2.477)	10	20	3	50	3	B	959535
2.48	(2.487)	10	20	3	50	3	B	200140
2.49	(2.497)	10	20	3	50	3	B	200141
2.50	(2.507)	10	20	3	50	3	B	200103
2.51	(2.517)	10	20	3	61	4	B	200142
2.52	(2.527)	10	20	3	61	4	B	200143
2.53	(2.537)	10	20	3	61	4	B	954733
2.54	(2.547)	10	20	3	61	4	B	955042
2.55	(2.557)	10	20	3	61	4	B	200118
2.56	(2.567)	10	20	3	61	4	B	326985
2.57	(2.577)	10	20	3	61	4	B	326986
2.58	(2.587)	10	20	3	61	4	B	958772
2.59	(2.597)	10	20	3	61	4	B	971141
2.60	(2.607)	10	20	3	61	4	B	200117
2.61	(2.617)	10	25	3	61	4	B	970909
2.62	(2.627)	10	25	3	61	4	B	952158

D nom. H7	D ₁ ± 1.5µm	L ₁	L ₂	D _{h5}	L	Z	Ref.	HM
2.63	(2.637)	10	25	3	61	4	B	326987
2.64	(2.647)	10	25	3	61	4	B	962551
2.65	(2.657)	10	25	3	61	4	B	200116
2.66	(2.667)	10	25	3	61	4	B	954075
2.67	(2.677)	10	25	3	61	4	B	200136
2.68	(2.687)	10	25	3	61	4	B	954450
2.69	(2.697)	10	25	3	61	4	B	991586
2.70	(2.707)	10	25	3	61	4	B	200123
2.71	(2.717)	10	25	3	61	4	B	954783
2.72	(2.727)	10	25	3	61	4	B	326988
2.73	(2.737)	10	25	3	61	4	B	326989
2.74	(2.747)	10	25	3	61	4	B	969786
2.75	(2.757)	10	25	3	61	4	B	200122
2.76	(2.767)	10	25	3	61	4	B	326990
2.77	(2.777)	10	25	3	61	4	B	326991
2.78	(2.787)	10	25	3	61	4	B	954734
2.79	(2.797)	10	25	3	61	4	B	965219
2.80	(2.807)	10	25	3	61	4	B	200138
2.81	(2.817)	10	25	3	61	4	B	953881
2.82	(2.827)	10	25	3	61	4	B	960888
2.83	(2.837)	10	25	3	61	4	B	326992
2.84	(2.847)	10	25	3	61	4	B	326993
2.85	(2.857)	10	25	3	61	4	B	200132
2.86	(2.867)	10	25	3	61	4	B	326994
2.87	(2.877)	10	25	3	61	4	B	326995
2.88	(2.887)	10	25	3	61	4	B	326996
2.89	(2.897)	10	25	3	61	4	B	953937
2.90	(2.907)	10	25	3	61	4	B	200133
2.91	(2.917)	10	25	3	61	4	B	964090
2.92	(2.927)	10	25	3	61	4	B	66683
2.93	(2.937)	10	25	3	61	4	B	326997
2.94	(2.947)	10	25	3	61	4	B	326998
2.95	(2.957)	10	25	3	61	4	B	200134
2.96	(2.967)	10	25	3	61	4	B	961012
2.97	(2.977)	10	25	3	61	4	B	959664
2.98	(2.987)	10	25	3	70	6	B	321202
2.99	(2.997)	10	25	3	70	6	B	321203
3.00	(3.007)	10	25	3	70	6	B	321204
3.01	(3.018)	10	25	3	70	6	B	321205
3.02	(3.028)	10	25	3	70	6	B	321206
3.03	(3.038)	10	25	3	70	6	B	321207
3.04	(3.048)	10	25	3	70	6	B	321208
3.05	(3.058)	10	25	3	70	6	B	321209
3.06	(3.068)	10	25	3	70	6	B	321210
3.07	(3.078)	10	25	3	70	6	B	321211
3.08	(3.088)	10	25	3	70	6	B	321212
3.09	(3.098)	10	25	3	70	6	B	321213



POLY 4001 - 4001-TC



P. 64



> Ø 2.98

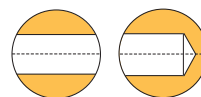

Ref. A



Ref. B

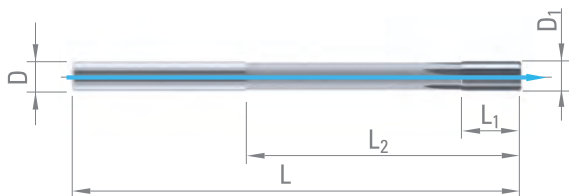

**DE STOCK
AB LAGER
A MAGAZZINO**

D nom. H7	D ₁ ± 1.5µm	L ₁	L ₂	D _{h5}	L	Z	Ref.	HM
3.10	(3.108)	10	-	3	70	6	A	321214
3.11	(3.118)	10	-	3	70	6	A	321215
3.12	(3.128)	10	-	3	70	6	A	321216
3.13	(3.138)	10	-	3	70	6	A	321217
3.14	(3.148)	10	-	3	70	6	A	321218
3.15	(3.158)	10	-	3	70	6	A	321219
3.16	(3.168)	10	-	3	70	6	A	321220
3.17	(3.178)	10	-	3	70	6	A	321221
3.18	(3.188)	10	-	3	70	6	A	321222
3.19	(3.198)	10	-	3	70	6	A	321223
3.20	(3.208)	10	-	3	70	6	A	321224
3.21	(3.218)	10	-	3	70	6	A	321225
3.22	(3.228)	10	-	3	70	6	A	321226
3.23	(3.238)	10	-	3	70	6	A	321227
3.24	(3.248)	10	-	3	70	6	A	321228
3.25	(3.258)	10	-	3	70	6	A	321229
3.26	(3.268)	10	-	3	70	6	A	321230
3.27	(3.278)	10	-	3	70	6	A	321231
3.28	(3.288)	10	-	3	70	6	A	321232
3.29	(3.298)	10	-	3	70	6	A	321233
3.30	(3.308)	10	-	3	70	6	A	321234
3.31	(3.318)	10	-	3	70	6	A	321235
3.32	(3.328)	10	-	3	70	6	A	321236
3.33	(3.338)	10	-	3	70	6	A	321237
3.34	(3.348)	10	-	3	70	6	A	321238
3.35	(3.358)	10	-	3	70	6	A	321239
3.36	(3.368)	10	-	3	70	6	A	321240
3.37	(3.378)	10	-	3	70	6	A	321241
3.38	(3.388)	10	-	3	70	6	A	321242
3.39	(3.398)	10	-	3	70	6	A	321243
3.40	(3.408)	10	-	3	70	6	A	321244
3.41	(3.418)	10	-	3	70	6	A	321245
3.42	(3.428)	10	-	3	70	6	A	321246
3.43	(3.438)	10	-	3	70	6	A	321247
3.44	(3.448)	10	-	3	70	6	A	321248
3.45	(3.458)	10	-	3	70	6	A	321249
3.46	(3.468)	10	-	3	70	6	A	321250
3.47	(3.478)	10	-	3	70	6	A	321251
3.48	(3.488)	10	-	3	70	6	A	321252
3.49	(3.498)	10	-	3	70	6	A	321253
3.50	(3.508)	10	-	3	70	6	A	321254
3.51	(3.518)	10	-	3	70	6	A	321255
3.52	(3.528)	10	-	3	70	6	A	321256
3.53	(3.538)	10	-	3	70	6	A	321257
3.54	(3.548)	10	-	3	70	6	A	321258
3.55	(3.558)	10	-	3	70	6	A	321259
3.56	(3.568)	10	-	3	70	6	A	321260

D nom. H7	D ₁ ± 1.5µm	L ₁	L ₂	D _{h5}	L	Z	Ref.	HM
3.57	(3.578)	10	-	3	70	6	A	321261
3.58	(3.588)	10	-	3	70	6	A	321262
3.59	(3.598)	10	-	3	70	6	A	321263
3.60	(3.608)	10	-	3	70	6	A	321264
3.61	(3.618)	10	-	3	70	6	A	321265
3.62	(3.628)	10	-	3	70	6	A	321266
3.63	(3.638)	10	-	3	70	6	A	321267
3.64	(3.648)	10	-	3	70	6	A	321268
3.65	(3.658)	10	-	3	70	6	A	321269
3.66	(3.668)	10	-	3	70	6	A	321270
3.67	(3.678)	10	-	3	70	6	A	321271
3.68	(3.688)	10	-	3	70	6	A	321272
3.69	(3.698)	10	-	3	70	6	A	321273
3.70	(3.708)	10	-	3	70	6	A	321274
3.71	(3.718)	10	-	3	70	6	A	321275
3.72	(3.728)	10	-	3	70	6	A	321276
3.73	(3.738)	10	-	3	70	6	A	321277
3.74	(3.748)	10	-	3	70	6	A	321278
3.75	(3.758)	10	-	3	70	6	A	321279
3.76	(3.768)	10	-	3	70	6	A	321280
3.77	(3.778)	10	-	3	70	6	A	321281
3.78	(3.788)	10	-	3	70	6	A	321282
3.79	(3.798)	10	-	3	70	6	A	321283
3.80	(3.808)	10	-	3	70	6	A	321284
3.81	(3.818)	10	-	3	70	6	A	321285
3.82	(3.828)	10	-	3	70	6	A	321286
3.83	(3.838)	10	-	3	70	6	A	321287
3.84	(3.848)	10	-	3	70	6	A	321288
3.85	(3.858)	10	-	3	70	6	A	321289
3.86	(3.868)	10	-	3	70	6	A	321290
3.87	(3.878)	10	-	3	70	6	A	321291
3.88	(3.888)	10	-	3	70	6	A	321292
3.89	(3.898)	10	-	3	70	6	A	321293
3.90	(3.908)	10	-	3	70	6	A	321294
3.91	(3.918)	10	-	3	70	6	A	321295
3.92	(3.928)	10	-	3	70	6	A	321296
3.93	(3.938)	10	-	3	70	6	A	321297
3.94	(3.948)	10	-	3	70	6	A	321298
3.95	(3.958)	10	-	3	70	6	A	321299
3.96	(3.968)	10	-	3	70	6	A	321300
3.97	(3.978)	10	-	3	70	6	A	321301
3.98	(3.988)	10	-	3	70	6	A	321302
3.99	(3.998)	10	-	3	70	6	A	321303
4.00	(4.008)	10	-	3	70	6	A	321304
4.01	(4.018)	10	-	3	70	6	A	321305
4.02	(4.028)	10	-	3	70	6	A	321306
4.03	(4.038)	10	-	3	70	6	A	321307



POLY 4001 - 4001-TC



P. 64

> Ø 2.98

**DE STOCK
AB LAGER
A MAGAZZINO**

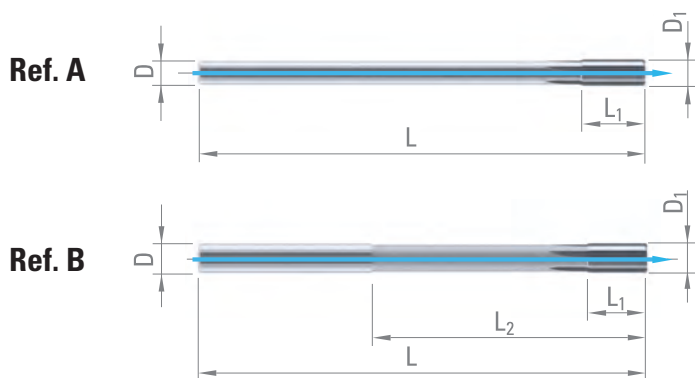

D nom. H7	D ₁ ± 1.5µm	L ₁	L ₂	D _{h5}	L	Z	Ref.	HM
4.04	(4.048)	10	-	3	70	6	A	321308
4.05	(4.058)	10	-	3	70	6	A	321309
4.06	(4.068)	10	-	3	70	6	A	321310
4.07	(4.078)	10	-	3	70	6	A	321311
4.08	(4.088)	10	-	3	70	6	A	321312
4.09	(4.098)	10	-	3	70	6	A	321313
4.10	(4.108)	12	-	4	80	6	A	321314
4.11	(4.118)	12	-	4	80	6	A	321315
4.12	(4.128)	12	-	4	80	6	A	321316
4.13	(4.138)	12	-	4	80	6	A	321317
4.14	(4.148)	12	-	4	80	6	A	321318
4.15	(4.158)	12	-	4	80	6	A	321319
4.16	(4.168)	12	-	4	80	6	A	321320
4.17	(4.178)	12	-	4	80	6	A	321321
4.18	(4.188)	12	-	4	80	6	A	321322
4.19	(4.198)	12	-	4	80	6	A	321323
4.20	(4.208)	12	-	4	80	6	A	321324
4.21	(4.218)	12	-	4	80	6	A	321325
4.22	(4.228)	12	-	4	80	6	A	321326
4.23	(4.238)	12	-	4	80	6	A	321327
4.24	(4.248)	12	-	4	80	6	A	321328
4.25	(4.258)	12	-	4	80	6	A	321329
4.26	(4.268)	12	-	4	80	6	A	321330
4.27	(4.278)	12	-	4	80	6	A	321331
4.28	(4.288)	12	-	4	80	6	A	321332
4.29	(4.298)	12	-	4	80	6	A	321333
4.30	(4.308)	12	-	4	80	6	A	321334
4.31	(4.318)	12	-	4	80	6	A	321335
4.32	(4.328)	12	-	4	80	6	A	321336
4.33	(4.338)	12	-	4	80	6	A	321337
4.34	(4.348)	12	-	4	80	6	A	321338
4.35	(4.358)	12	-	4	80	6	A	321339
4.36	(4.368)	12	-	4	80	6	A	321340
4.37	(4.378)	12	-	4	80	6	A	321341
4.38	(4.388)	12	-	4	80	6	A	321342
4.39	(4.398)	12	-	4	80	6	A	321343
4.40	(4.408)	12	-	4	80	6	A	321344
4.41	(4.418)	12	-	4	80	6	A	321345
4.42	(4.428)	12	-	4	80	6	A	321346
4.43	(4.438)	12	-	4	80	6	A	321347
4.44	(4.448)	12	-	4	80	6	A	321348
4.45	(4.458)	12	-	4	80	6	A	321349
4.46	(4.468)	12	-	4	80	6	A	321350
4.47	(4.478)	12	-	4	80	6	A	321351
4.48	(4.488)	12	-	4	80	6	A	321352
4.49	(4.498)	12	-	4	80	6	A	321353
4.50	(4.508)	12	-	4	80	6	A	321354

D nom. H7	D ₁ ± 1.5µm	L ₁	L ₂	D _{h5}	L	Z	Ref.	HM
4.51	(4.518)	12	-	4	80	6	A	321355
4.52	(4.528)	12	-	4	80	6	A	321356
4.53	(4.538)	12	-	4	80	6	A	321357
4.54	(4.548)	12	-	4	80	6	A	321358
4.55	(4.558)	12	-	4	80	6	A	321359
4.56	(4.568)	12	-	4	80	6	A	321360
4.57	(4.578)	12	-	4	80	6	A	321361
4.58	(4.588)	12	-	4	80	6	A	321362
4.59	(4.598)	12	-	4	80	6	A	321363
4.60	(4.608)	12	-	4	80	6	A	321364
4.61	(4.618)	12	-	4	80	6	A	321365
4.62	(4.628)	12	-	4	80	6	A	321366
4.63	(4.638)	12	-	4	80	6	A	321367
4.64	(4.648)	12	-	4	80	6	A	321368
4.65	(4.658)	12	-	4	80	6	A	321369
4.66	(4.668)	12	-	4	80	6	A	321370
4.67	(4.678)	12	-	4	80	6	A	321371
4.68	(4.688)	12	-	4	80	6	A	321372
4.69	(4.698)	12	-	4	80	6	A	321373
4.70	(4.708)	12	-	4	80	6	A	321374
4.71	(4.718)	12	-	4	80	6	A	321375
4.72	(4.728)	12	-	4	80	6	A	321376
4.73	(4.738)	12	-	4	80	6	A	321377
4.74	(4.748)	12	-	4	80	6	A	321378
4.75	(4.758)	12	-	4	80	6	A	321379
4.76	(4.768)	12	-	4	80	6	A	321380
4.77	(4.778)	12	-	4	80	6	A	321381
4.78	(4.788)	12	-	4	80	6	A	321382
4.79	(4.798)	12	-	4	80	6	A	321383
4.80	(4.808)	12	-	4	80	6	A	321384
4.81	(4.818)	12	-	4	80	6	A	321385
4.82	(4.828)	12	-	4	80	6	A	321386
4.83	(4.838)	12	-	4	80	6	A	321387
4.84	(4.848)	12	-	4	80	6	A	321388
4.85	(4.858)	12	-	4	80	6	A	321389
4.86	(4.868)	12	-	4	80	6	A	321390
4.87	(4.878)	12	-	4	80	6	A	321391
4.88	(4.888)	12	-	4	80	6	A	321392
4.89	(4.898)	12	-	4	80	6	A	321393
4.90	(4.908)	12	-	4	80	6	A	321394
4.91	(4.918)	12	-	4	80	6	A	321395
4.92	(4.928)	12	-	4	80	6	A	321396
4.93	(4.938)	12	-	4	80	6	A	321397
4.94	(4.948)	12	-	4	80	6	A	321398
4.95	(4.958)	12	-	4	80	6	A	321399
4.96	(4.968)	12	-	4	80	6	A	321400
4.97	(4.978)	12	-	4	80	6	A	321401



POLY 4001 - 4001-TC



P. 64



> Ø 2.98

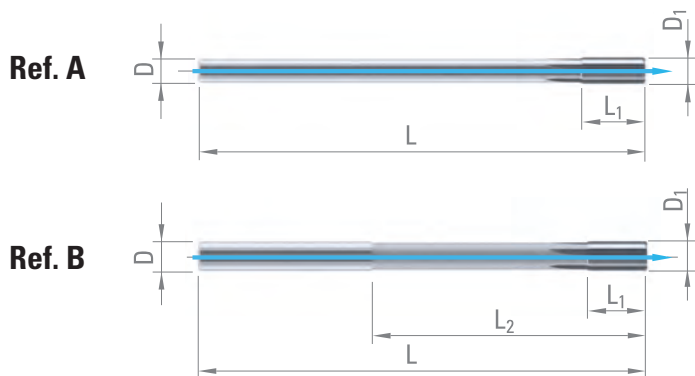
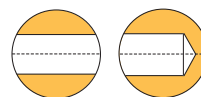

**DE STOCK
AB LAGER
A MAGAZZINO**

D nom. H7	D ₁ ± 1.5µm	L ₁	L ₂	D _{h5}	L	Z	Ref.	HM
4.98 (4.988)	12	-	4	80	6	A	321402	
4.99 (4.998)	12	-	4	80	6	A	321403	
5.00 (5.008)	12	-	4	80	6	A	321404	
5.01 (5.018)	12	-	4	80	6	A	321405	
5.02 (5.028)	12	-	4	80	6	A	321406	
5.03 (5.038)	12	-	4	80	6	A	321407	
5.04 (5.048)	12	-	4	80	6	A	321408	
5.05 (5.058)	12	-	4	80	6	A	321409	
5.06 (5.068)	12	-	4	80	6	A	321410	
5.07 (5.078)	12	-	4	80	6	A	321411	
5.08 (5.088)	12	-	4	80	6	A	321412	
5.09 (5.098)	12	-	4	80	6	A	321413	
5.10 (5.108)	12	-	4	80	6	A	321414	
5.11 (5.118)	12	-	4	80	6	A	321415	
5.12 (5.128)	12	-	4	80	6	A	321416	
5.13 (5.138)	12	-	4	80	6	A	321417	
5.14 (5.148)	12	-	4	80	6	A	321418	
5.15 (5.158)	12	-	4	80	6	A	321419	
5.16 (5.168)	12	-	4	80	6	A	321420	
5.17 (5.178)	12	-	4	80	6	A	321421	
5.18 (5.188)	12	-	4	80	6	A	321422	
5.19 (5.198)	12	-	4	80	6	A	321423	
5.20 (5.208)	12	-	4	80	6	A	321424	
5.21 (5.218)	12	-	4	80	6	A	321425	
5.22 (5.228)	12	-	4	80	6	A	321426	
5.23 (5.238)	12	-	4	80	6	A	321427	
5.24 (5.248)	12	-	4	80	6	A	321428	
5.25 (5.258)	12	-	4	80	6	A	321429	
5.26 (5.268)	12	-	4	80	6	A	321430	
5.27 (5.278)	12	-	4	80	6	A	321431	
5.28 (5.288)	12	-	4	80	6	A	321432	
5.29 (5.298)	12	-	4	80	6	A	321433	
5.30 (5.308)	12	-	4	80	6	A	321434	
5.31 (5.318)	12	-	4	80	6	A	321435	
5.32 (5.328)	12	-	4	80	6	A	321436	
5.33 (5.338)	12	-	4	80	6	A	321437	
5.34 (5.348)	12	-	4	80	6	A	321438	
5.35 (5.358)	12	-	4	80	6	A	321439	
5.36 (5.368)	12	-	4	80	6	A	321440	
5.37 (5.378)	12	-	4	80	6	A	321441	
5.38 (5.388)	12	-	4	80	6	A	321442	
5.39 (5.398)	12	-	4	80	6	A	321443	
5.40 (5.408)	12	-	4	80	6	A	321444	
5.41 (5.418)	12	-	4	80	6	A	321445	
5.42 (5.428)	12	-	4	80	6	A	321446	
5.43 (5.438)	12	-	4	80	6	A	321447	
5.44 (5.448)	12	-	4	80	6	A	321448	

D nom. H7	D ₁ ± 1.5µm	L ₁	L ₂	D _{h5}	L	Z	Ref.	HM
5.45 (5.458)	12	-	4	80	6	A	321449	
5.46 (5.468)	12	-	4	80	6	A	321450	
5.47 (5.478)	12	-	4	80	6	A	321451	
5.48 (5.488)	12	-	4	80	6	A	321452	
5.49 (5.498)	12	-	4	80	6	A	321453	
5.50 (5.508)	12	-	4	80	6	A	321454	
5.51 (5.518)	12	-	4	80	6	A	321455	
5.52 (5.528)	12	-	4	80	6	A	321456	
5.53 (5.538)	12	-	4	80	6	A	321457	
5.54 (5.548)	12	-	4	80	6	A	321458	
5.55 (5.558)	12	-	4	80	6	A	321459	
5.56 (5.568)	12	-	4	80	6	A	321460	
5.57 (5.578)	12	-	4	80	6	A	321461	
5.58 (5.588)	12	-	4	80	6	A	321462	
5.59 (5.598)	12	-	4	80	6	A	321463	
5.60 (5.608)	12	-	4	80	6	A	321464	
5.61 (5.618)	12	-	4	80	6	A	321465	
5.62 (5.628)	12	-	4	80	6	A	321466	
5.63 (5.638)	12	-	4	80	6	A	321467	
5.64 (5.648)	12	-	4	80	6	A	321468	
5.65 (5.658)	12	-	4	80	6	A	321469	
5.66 (5.668)	12	-	4	80	6	A	321470	
5.67 (5.678)	12	-	4	80	6	A	321471	
5.68 (5.688)	12	-	4	80	6	A	321472	
5.69 (5.698)	12	-	4	80	6	A	321473	
5.70 (5.708)	12	-	4	80	6	A	321474	
5.71 (5.718)	12	-	4	80	6	A	321475	
5.72 (5.728)	12	-	4	80	6	A	321476	
5.73 (5.738)	12	-	4	80	6	A	321477	
5.74 (5.748)	12	-	4	80	6	A	321478	
5.75 (5.758)	12	-	4	80	6	A	321479	
5.76 (5.768)	12	-	4	80	6	A	321480	
5.77 (5.778)	12	-	4	80	6	A	321481	
5.78 (5.788)	12	-	4	80	6	A	321482	
5.79 (5.798)	12	-	4	80	6	A	321483	
5.80 (5.808)	12	-	4	80	6	A	321484	
5.81 (5.818)	12	-	4	80	6	A	321485	
5.82 (5.828)	12	-	4	80	6	A	321486	
5.83 (5.838)	12	-	4	80	6	A	321487	
5.84 (5.848)	12	-	4	80	6	A	321488	
5.85 (5.858)	12	-	4	80	6	A	321489	
5.86 (5.868)	12	-	4	80	6	A	321490	
5.87 (5.878)	12	-	4	80	6	A	321491	
5.88 (5.888)	12	-	4	80	6	A	321492	
5.89 (5.898)	12	-	4	80	6	A	321493	
5.90 (5.908)	12	-	4	80	6	A	321494	
5.91 (5.918)	12	-	4	80	6	A	321495	



POLY 4001 - 4001-TC



P. 64

> Ø 2.98

**DE STOCK
AB LAGER
A MAGAZZINO**

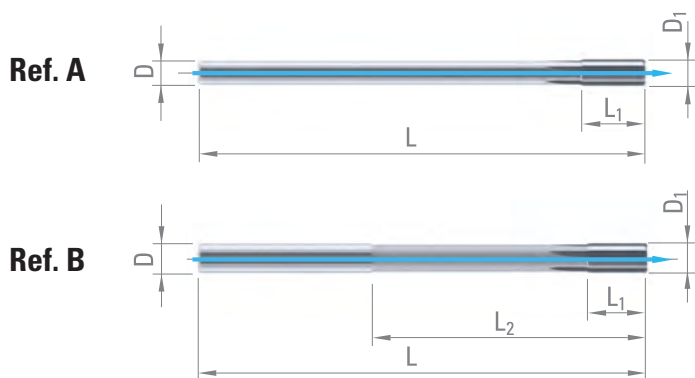

D nom. H7	D ₁ ± 1.5µm	L ₁	L ₂	D _{h5}	L	Z	Ref.	HM
5.92	(5.928)	12	-	4	80	6	A	321496
5.93	(5.938)	12	-	4	80	6	A	321497
5.94	(5.948)	12	-	4	80	6	A	321498
5.95	(5.958)	12	-	4	80	6	A	321499
5.96	(5.968)	12	-	4	80	6	A	321500
5.97	(5.978)	12	-	4	80	6	A	321501
5.98	(5.988)	12	-	4	80	6	A	321502
5.99	(5.998)	12	-	4	80	6	A	321503
6.00	(6.008)	12	-	4	80	6	A	321504
6.01	(6.020)	12	-	4	80	6	A	321505
6.02	(6.030)	12	-	4	80	6	A	321506
6.03	(6.040)	12	-	4	80	6	A	321507
6.04	(6.050)	12	-	4	80	6	A	321508
6.05	(6.060)	12	-	4	80	6	A	321509
6.06	(6.070)	12	-	4	80	6	A	321510
6.07	(6.080)	12	-	4	80	6	A	321511
6.08	(6.090)	12	-	4	80	6	A	321512
6.09	(6.100)	12	-	4	80	6	A	321513
6.10	(6.110)	12	-	4	80	6	A	321514
6.11	(6.120)	12	-	4	80	6	A	321515
6.12	(6.130)	12	-	4	80	6	A	321516
6.13	(6.140)	12	-	4	80	6	A	321517
6.14	(6.150)	12	-	4	80	6	A	321518
6.15	(6.160)	12	-	4	80	6	A	321519
6.16	(6.170)	12	-	4	80	6	A	321520
6.17	(6.180)	12	-	4	80	6	A	321521
6.18	(6.190)	12	-	4	80	6	A	321522
6.19	(6.200)	12	-	4	80	6	A	321523
6.20	(6.210)	16	-	6	101	6	A	341670
6.30	(6.310)	16	-	6	101	6	A	341680
6.35	(6.360)	16	-	6	101	6	A	341685
6.40	(6.410)	16	-	6	101	6	A	341690
6.48	(6.490)	16	-	6	101	6	A	341698
6.49	(6.500)	16	-	6	101	6	A	341699
6.50	(6.510)	16	-	6	101	6	A	341700
6.51	(6.520)	16	-	6	101	6	A	341701
6.52	(6.530)	16	-	6	101	6	A	341702
6.55	(6.560)	16	-	6	101	6	A	341705
6.60	(6.610)	16	-	6	101	6	A	341710
6.70	(6.710)	16	-	6	101	6	A	341720
6.80	(6.810)	16	-	6	101	6	A	341730
6.90	(6.910)	16	-	6	101	6	A	341740
7.00	(7.010)	16	-	6	101	6	A	341750

D nom. H7	D ₁ ± 1.5µm	L ₁	L ₂	D _{h5}	L	Z	Ref.	HM
7.01	(7.020)	16	-	6	101	6	A	341751
7.02	(7.030)	16	-	6	101	6	A	341752
7.10	(7.110)	16	-	6	101	6	A	341760
7.20	(7.210)	16	-	6	101	6	A	341770
7.30	(7.310)	16	-	6	101	6	A	341780
7.40	(7.410)	16	-	6	101	6	A	341790
7.50	(7.510)	16	-	6	101	6	A	341800
7.60	(7.610)	16	-	6	101	6	A	341810
7.70	(7.710)	16	-	6	101	6	A	341820
7.80	(7.810)	16	-	6	101	6	A	341830
7.90	(7.910)	16	-	6	101	6	A	341840
7.98	(7.990)	16	-	6	101	6	A	341848
7.99	(8.000)	16	-	6	101	6	A	341849
8.00	(8.010)	16	-	6	101	6	A	341850
8.01	(8.020)	16	-	6	101	6	A	341851
8.02	(8.030)	16	-	6	101	6	A	341852
8.05	(8.060)	16	-	6	101	6	A	341855
8.10	(8.110)	16	-	6	117	6	A	341860
8.20	(8.210)	16	-	6	117	6	A	341870
8.30	(8.310)	16	-	6	117	6	A	341880
8.40	(8.410)	16	-	6	117	6	A	341890
8.50	(8.510)	16	-	6	117	6	A	341900
8.70	(8.710)	16	-	6	117	6	A	341920
9.00	(9.010)	16	-	6	117	6	A	341950
9.30	(9.310)	16	-	6	117	6	A	341980
9.50	(9.510)	16	-	6	117	6	A	342000
9.70	(9.710)	16	-	6	117	6	A	342020
9.98	(9.990)	16	-	6	117	6	A	342048
9.99	(10.000)	16	-	6	117	6	A	342049
10.00	(10.010)	16	-	6	117	6	A	342050
10.01	(10.020)	16	-	6	117	6	A	342051
10.02	(10.032)	19	87	10	133	6	B	952322
10.04	(10.052)	19	87	10	133	6	B	962649
10.05	(10.062)	19	87	10	133	6	B	962568
10.10	(10.112)	19	87	10	133	6	B	952765
10.40	(10.412)	19	87	10	133	6	B	968160
10.50	(10.512)	19	87	10	133	6	B	952766
10.60	(10.612)	19	87	10	133	6	B	952767
11.00	(11.012)	19	96	12	142	6	B	952768
11.50	(11.512)	19	96	12	142	6	B	952769
11.80	(11.812)	19	96	12	142	6	B	952770
12.00	(12.012)	19	105	12	151	6	B	952771
12.02	(12.032)	19	105	12	151	6	B	952772

Tout Ø avec tolérance ±2µm livrable sur demande via notre service rapide

Alle Ø mit Toleranz ±2µm lieferbar durch unseren Express-Service

Ogni Ø con tolleranza ±2µm consegnabili tramite nostro servizio rapido



POLY 4005-TC

ALÉSOIRS EN CARBURE MONOBLOC, HÉLICE À DROITE
 VHM-REIBAHLEN, RECHTS SPIRALISIERT
 ALESATORI IN METALLO DURO INTEGRALE, ELICA DESTRA

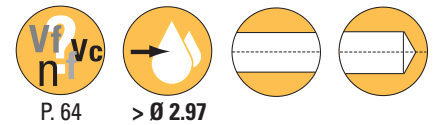

**DE STOCK
 AB LAGER
 A MAGAZZINO**

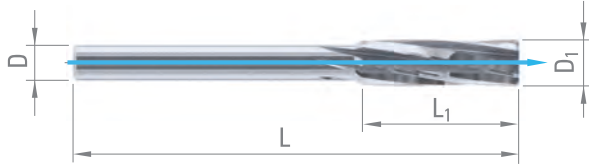

D nom. H7	D ₁ ± 1.5µm	L ₁	D _{h5}	L	Z	HM	D nom. H7	D ₁ ± 1.5µm	L ₁	D _{h5}	L	Z	HM
2.97	(2.977)	20	2.5	56	4	969074	3.75	(3.758)	20	3.0	56	4	969430
2.99	(2.997)	20	2.5	56	4	969379	3.78	(3.788)	20	3.0	56	4	969431
3.00	(3.007)	20	2.5	56	4	969382	3.80	(3.808)	20	3.0	56	4	969432
3.01	(3.018)	20	2.5	56	4	969398	3.85	(3.858)	20	3.0	56	4	969433
3.02	(3.028)	20	2.5	56	4	969399	3.90	(3.908)	20	3.0	56	4	969434
3.05	(3.058)	20	2.5	56	4	969400	3.95	(3.958)	20	3.0	56	4	969435
3.08	(3.088)	20	2.5	56	4	969401	4.00	(4.008)	20	3.0	56	4	969436
3.10	(3.108)	20	2.5	56	4	969402	4.04	(4.048)	22	3.5	63	6	993718
3.11	(3.118)	20	2.5	56	4	969403	4.10	(4.108)	22	3.5	63	6	969437
3.15	(3.158)	20	2.5	56	4	969404	4.20	(4.208)	22	3.5	63	6	969438
3.18	(3.188)	20	2.5	56	4	969405	4.30	(4.308)	22	3.5	63	6	969439
3.20	(3.208)	20	2.5	56	4	969406	4.40	(4.408)	22	3.5	63	6	969440
3.21	(3.218)	20	2.5	56	4	969407	4.50	(4.508)	22	4.0	63	6	969441
3.25	(3.258)	20	2.5	56	4	969408	4.60	(4.608)	22	4.0	63	6	969442
3.28	(3.288)	20	2.5	56	4	969409	4.70	(4.708)	22	4.0	63	6	969443
3.30	(3.308)	20	2.5	56	4	969410	4.80	(4.808)	22	4.0	63	6	969444
3.31	(3.318)	20	2.5	56	4	969411	4.90	(4.908)	22	4.0	63	6	969445
3.35	(3.358)	20	2.5	56	4	969412	5.00	(5.008)	22	4.0	63	6	969446
3.38	(3.388)	20	2.5	56	4	969413	5.10	(5.108)	22	4.0	63	6	969447
3.40	(3.408)	20	2.5	56	4	969414	5.20	(5.208)	22	4.0	63	6	969448
3.41	(3.418)	20	2.5	56	4	969415	5.30	(5.308)	22	4.0	63	6	969449
3.45	(3.458)	20	2.5	56	4	969416	5.40	(5.408)	22	4.0	63	6	969450
3.49	(3.498)	20	2.5	56	4	969417	5.50	(5.508)	22	5.0	63	6	969451
3.50	(3.508)	20	3.0	56	4	969418	5.60	(5.608)	22	5.0	63	6	969452
3.51	(3.518)	20	3.0	56	4	969421	5.70	(5.708)	22	5.0	63	6	969453
3.55	(3.558)	20	3.0	56	4	969422	5.80	(5.808)	22	5.0	63	6	969454
3.58	(3.588)	20	3.0	56	4	969423	5.90	(5.908)	22	5.0	63	6	969455
3.60	(3.608)	20	3.0	56	4	969424	6.00	(6.008)	22	5.0	63	6	969456
3.61	(3.618)	20	3.0	56	4	969425	6.10	(6.110)	22	5.0	63	6	969457
3.65	(3.658)	20	3.0	56	4	969426	6.20	(6.210)	22	5.0	63	6	969458
3.68	(3.688)	20	3.0	56	4	969427	6.30	(6.310)	22	5.0	63	6	969459
3.70	(3.708)	20	3.0	56	4	969428	6.40	(6.410)	22	5.0	63	6	969460
3.71	(3.718)	20	3.0	56	4	969429	6.50	(6.510)	22	5.0	63	6	969461

Tout Ø avec tolérance ±2µm livrable sur demande via notre service rapide
Alle Ø mit Toleranz ±2µm lieferbar durch unseren Express-Service
Ogni Ø con tolleranza ±2µm consegnabili tramite nostro servizio rapido

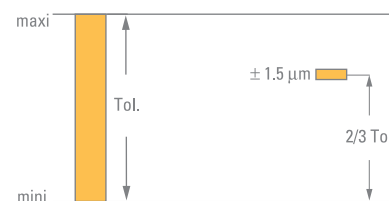

P. 73



POLY 4007 - 4007-TC

ALÉSOIRS EN CARBURE MONOBLOC, HÉLICE À GAUCHE
 VHM-REIBAHLEN, LINKS SPIRALISIERT
 ALESATORI IN METALLO DURO INTEGRALE, ELICA SINISTRA



P. 64



> Ø 2.97



**DE STOCK
 AB LAGER
 A MAGAZZINO**

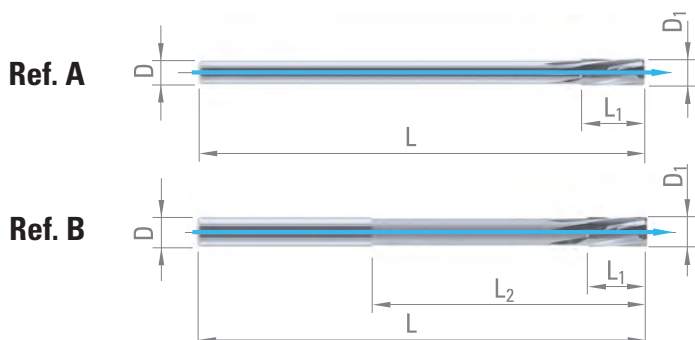

D _{10/+0.003}	L ₁	L ₂	D _{h5}	L	Z	Ref.	HM
0.37	3	5	3	38	3	B	983079
0.38	3	5	3	38	3	B	326999
0.39	3	5	3	38	3	B	969543
0.40	3	5	3	38	3	B	200716
0.41	3	5	3	38	3	B	963823
0.42	3	5	3	38	3	B	200717
0.43	3	5	3	38	3	B	327000
0.44	3	5	3	38	3	B	200718
0.45	3	5	3	38	3	B	965207
0.46	3	5	3	38	3	B	200719
0.47	3	5	3	38	3	B	327001
0.48	3	5	3	38	3	B	200720
0.49	3	5	3	38	3	B	963716
0.50	3	5	3	38	3	B	200746
0.51	4	6	3	38	3	B	200745
0.52	4	6	3	38	3	B	200738
0.53	4	6	3	38	3	B	200742
0.54	4	6	3	38	3	B	200743
0.55	4	6	3	38	3	B	200739
0.56	4	6	3	38	3	B	968834
0.57	4	6	3	38	3	B	973253
0.58	4	6	3	38	3	B	200741
0.59	4	6	3	38	3	B	200744
0.60	4	6	3	38	3	B	200740
0.61	4	7	3	38	3	B	964652
0.62	4	7	3	38	3	B	200750
0.63	4	7	3	38	3	B	327002
0.64	4	7	3	38	3	B	200755
0.65	4	7	3	38	3	B	200748
0.66	4	7	3	38	3	B	200752
0.67	4	7	3	38	3	B	200753
0.68	4	7	3	38	3	B	200751
0.69	4	7	3	38	3	B	200754
0.70	4	7	3	38	3	B	200749
0.71	4	8	3	38	3	B	965167
0.72	4	8	3	38	3	B	200758
0.73	4	8	3	38	3	B	327003
0.74	4	8	3	38	3	B	200762
0.75	4	8	3	38	3	B	200756
0.76	4	8	3	38	3	B	327004
0.77	4	8	3	38	3	B	200760
0.78	4	8	3	38	3	B	200759
0.79	4	8	3	38	3	B	200761
0.80	4	8	3	38	3	B	200757
0.81	5	9	3	38	3	B	965168

D _{10/+0.003}	L ₁	L ₂	D _{h5}	L	Z	Ref.	HM
0.82	5	9	3	38	3	B	200765
0.83	5	9	3	38	3	B	200769
0.84	5	9	3	38	3	B	200768
0.85	5	9	3	38	3	B	200763
0.86	5	9	3	38	3	B	200770
0.87	5	9	3	38	3	B	200771
0.88	5	9	3	38	3	B	200766
0.89	5	9	3	38	3	B	200767
0.90	5	9	3	38	3	B	200764
0.91	5	10	3	38	3	B	200733
0.92	5	10	3	38	3	B	200729
0.93	5	10	3	38	3	B	327005
0.94	5	10	3	38	3	B	327006
0.95	5	10	3	38	3	B	200728
0.96	5	10	3	38	3	B	200730
0.97	5	10	3	38	3	B	200731
0.98	5	10	3	38	3	B	200726
0.99	5	10	3	38	3	B	200727
1.00	5	10	3	38	3	B	200732
1.01	5	11	3	38	3	B	200715
1.02	5	11	3	38	3	B	200772
1.03	5	11	3	38	3	B	967191
1.04	5	11	3	38	3	B	327007
1.05	5	11	3	38	3	B	200773
1.06	5	11	3	38	3	B	327008
1.07	5	11	3	38	3	B	327009
1.08	5	11	3	38	3	B	200774
1.09	5	11	3	38	3	B	965169
1.10	5	11	3	38	3	B	200777
1.11	5	12	3	38	3	B	327010
1.12	5	12	3	38	3	B	327011
1.13	5	12	3	38	3	B	327012
1.14	5	12	3	38	3	B	327013
1.15	5	12	3	38	3	B	200775
1.16	5	12	3	38	3	B	327014
1.17	5	12	3	38	3	B	327015
1.18	5	12	3	38	3	B	63965
1.19	5	12	3	38	3	B	327016
1.20	5	12	3	38	3	B	200776
1.21	6	13	3	38	3	B	965171
1.22	6	13	3	38	3	B	327017
1.23	6	13	3	38	3	B	327018
1.24	6	13	3	38	3	B	327019
1.25	6	13	3	38	3	B	200778
1.26	6	13	3	38	3	B	963588

Tout Ø avec tolérance ±2µm livrable sur demande via notre service rapide
 Alle Ø mit Toleranz ±2µm lieferbar durch unseren Express-Service
 Ogni Ø con tolleranza ±2µm consegnabili tramite nostro servizio rapido





P. 64



> Ø 2.97



Ref. A



Ref. B

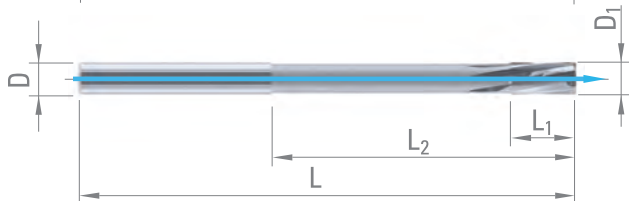

**DE STOCK
AB LAGER
A MAGAZZINO**

D _{10/+0.003}	L ₁	L ₂	D _{h5}	L	Z	Ref.	HM
1.27	6	13	3	38	3	B	972014
1.28	6	13	3	38	3	B	200780
1.29	6	13	3	38	3	B	327020
1.30	6	13	3	38	3	B	200779
1.31	6	13	3	38	3	B	967299
1.32	6	13	3	38	3	B	327021
1.33	6	13	3	38	3	B	327022
1.34	6	13	3	38	3	B	973390
1.35	6	13	3	38	3	B	200734
1.36	6	13	3	38	3	B	327023
1.37	6	13	3	38	3	B	327024
1.38	6	13	3	38	3	B	327025
1.39	6	13	3	38	3	B	327026
1.40	6	13	3	38	3	B	200735
1.41	7	15	3	38	3	B	327027
1.42	7	15	3	38	3	B	327028
1.43	7	15	3	38	3	B	327029
1.44	7	15	3	38	3	B	327030
1.45	7	15	3	38	3	B	200783
1.46	7	15	3	38	3	B	327031
1.47	7	15	3	38	3	B	327032
1.48	7	15	3	38	3	B	200781
1.49	7	15	3	38	3	B	200782
1.50	7	15	3	38	3	B	200784
1.51	7	15	3	50	3	B	200787
1.52	7	15	3	50	3	B	200788
1.53	7	15	3	50	3	B	327033
1.54	7	15	3	50	3	B	327034
1.55	7	15	3	50	3	B	200692
1.56	7	15	3	50	3	B	976176
1.57	7	15	3	50	3	B	964655
1.58	7	15	3	50	3	B	63966
1.59	7	15	3	50	3	B	965174
1.60	7	15	3	50	3	B	200794
1.61	7	16	3	50	3	B	965175
1.62	7	16	3	50	3	B	327035
1.63	7	16	3	50	3	B	327036
1.64	7	16	3	50	3	B	327037
1.65	7	16	3	50	3	B	200691
1.66	7	16	3	50	3	B	327038
1.67	7	16	3	50	3	B	327039
1.68	7	16	3	50	3	B	327040
1.69	7	16	3	50	3	B	965209
1.70	7	16	3	50	3	B	200693
1.71	7	17	3	50	3	B	327041
1.72	7	17	3	50	3	B	327042
1.73	7	17	3	50	3	B	327043

D _{10/+0.003}	L ₁	L ₂	D _{h5}	L	Z	Ref.	HM
1.74	7	17	3	50	3	B	327044
1.75	7	17	3	50	3	B	200694
1.76	7	17	3	50	3	B	327045
1.77	7	17	3	50	3	B	327046
1.78	7	17	3	50	3	B	327047
1.79	7	17	3	50	3	B	200713
1.80	7	17	3	50	3	B	200795
1.81	8	17	3	50	3	B	327048
1.82	8	17	3	50	3	B	327049
1.83	8	17	3	50	3	B	971471
1.84	8	17	3	50	3	B	327050
1.85	8	17	3	50	3	B	200796
1.86	8	17	3	50	3	B	972720
1.87	8	17	3	50	3	B	964530
1.88	8	17	3	50	3	B	971918
1.89	8	17	3	50	3	B	200704
1.90	8	17	3	50	3	B	20079
1.91	8	18	3	50	3	B	965177
1.92	8	18	3	50	3	B	327051
1.93	8	18	3	50	3	B	327052
1.94	8	18	3	50	3	B	327053
1.95	8	18	3	50	3	B	200682
1.96	8	18	3	50	3	B	200712
1.97	8	18	3	50	3	B	200789
1.98	8	18	3	50	3	B	200790
1.99	8	18	3	50	3	B	200791
2.00	8	18	3	50	3	B	200785
2.01	8	18	3	50	3	B	200792
2.02	8	18	3	50	3	B	200793
2.03	8	18	3	50	3	B	327054
2.04	8	18	3	50	3	B	200714
2.05	8	18	3	50	3	B	200688
2.06	8	18	3	50	3	B	327055
2.07	8	18	3	50	3	B	327056
2.08	8	18	3	50	3	B	327057
2.09	8	18	3	50	3	B	968093
2.10	8	18	3	50	3	B	200711
2.11	8	18	3	50	3	B	327058
2.12	8	18	3	50	3	B	968735
2.13	8	18	3	50	3	B	327059
2.14	8	18	3	50	3	B	968737
2.15	8	18	3	50	3	B	200687
2.16	8	18	3	50	3	B	327060
2.17	8	18	3	50	3	B	327061
2.18	8	18	3	50	3	B	327062
2.19	8	18	3	50	3	B	967119
2.20	8	18	3	50	3	B	200706



POLY 4007 - 4007-TC



P. 64

> Ø 2.97

**DE STOCK
AB LAGER
A MAGAZZINO**

Ref. A



Ref. B

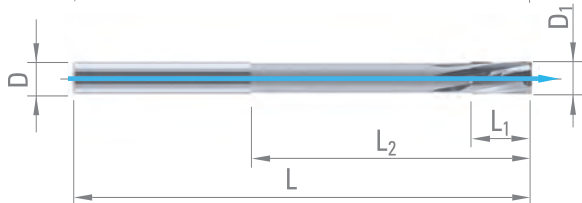

D _{10/+0.003}	L ₁	L ₂	D _{h5}	L	Z	Ref.	HM
2.21	8	18	3	50	3	B	327063
2.22	8	18	3	50	3	B	327064
2.23	8	18	3	50	3	B	327065
2.24	8	18	3	50	3	B	327066
2.25	8	18	3	50	3	B	200686
2.26	8	18	3	50	3	B	327067
2.27	8	18	3	50	3	B	327068
2.28	8	18	3	50	3	B	327069
2.29	8	18	3	50	3	B	327070
2.30	8	18	3	50	3	B	200698
2.31	10	20	3	50	3	B	327071
2.32	10	20	3	50	3	B	200702
2.33	10	20	3	50	3	B	327072
2.34	10	20	3	50	3	B	327073
2.35	10	20	3	50	3	B	200697
2.36	10	20	3	50	3	B	327074
2.37	10	20	3	50	3	B	327075
2.38	10	20	3	50	3	B	327076
2.39	10	20	3	50	3	B	327077
2.40	10	20	3	50	3	B	200696
2.41	10	20	3	50	3	B	972007
2.42	10	20	3	50	3	B	327078
2.43	10	20	3	50	3	B	327079
2.44	10	20	3	50	3	B	327080
2.45	10	20	3	50	3	B	200695
2.46	10	20	3	50	3	B	327081
2.47	10	20	3	50	3	B	327082
2.48	10	20	3	50	3	B	200707
2.49	10	20	3	50	3	B	200708
2.50	10	20	3	50	3	B	200786
2.51	10	20	3	61	4	B	200709
2.52	10	20	3	61	4	B	200710
2.53	10	20	3	61	4	B	327083
2.54	10	20	3	61	4	B	327084
2.55	10	20	3	61	4	B	200685
2.56	10	20	3	61	4	B	327085
2.57	10	20	3	61	4	B	327086
2.58	10	20	3	61	4	B	327087
2.59	10	20	3	61	4	B	327088
2.60	10	20	3	61	4	B	200684
2.61	10	25	3	61	4	B	327089
2.62	10	25	3	61	4	B	327090
2.63	10	25	3	61	4	B	327091
2.64	10	25	3	61	4	B	327092
2.65	10	25	3	61	4	B	200683
2.66	10	25	3	61	4	B	327093
2.67	10	25	3	61	4	B	200703

D _{10/+0.003}	L ₁	L ₂	D _{h5}	L	Z	Ref.	HM
2.68	10	25	3	61	4	B	327094
2.69	10	25	3	61	4	B	327095
2.70	10	25	3	61	4	B	200690
2.71	10	25	3	61	4	B	327096
2.72	10	25	3	61	4	B	327097
2.73	10	25	3	61	4	B	327098
2.74	10	25	3	61	4	B	327099
2.75	10	25	3	61	4	B	200689
2.76	10	25	3	61	4	B	327100
2.77	10	25	3	61	4	B	327101
2.78	10	25	3	61	4	B	327102
2.79	10	25	3	61	4	B	327103
2.80	10	25	3	61	4	B	200705
2.81	10	25	3	61	4	B	327104
2.82	10	25	3	61	4	B	327105
2.83	10	25	3	61	4	B	327106
2.84	10	25	3	61	4	B	327107
2.85	10	25	3	61	4	B	200699
2.86	10	25	3	61	4	B	327108
2.87	10	25	3	61	4	B	327109
2.88	10	25	3	61	4	B	327110
2.89	10	25	3	61	4	B	327111
2.90	10	25	3	61	4	B	200700
2.91	10	25	3	61	4	B	327112
2.92	10	25	3	61	4	B	327113
2.93	10	25	3	61	4	B	327114
2.94	10	25	3	61	4	B	327115
2.95	10	25	3	61	4	B	200701
2.96	10	25	3	61	4	B	327116
2.97	10	25	3	61	4	B	200747
2.98	10	25	3	70	6	B	321524
2.99	10	25	3	70	6	B	321525
3.00	10	25	3	70	6	B	321526
3.01	10	25	3	70	6	B	321527
3.02	10	25	3	70	6	B	321528
3.03	10	25	3	70	6	B	321529
3.04	10	25	3	70	6	B	321530
3.05	10	25	3	70	6	B	321531
3.06	10	25	3	70	6	B	321532
3.07	10	25	3	70	6	B	321533
3.08	10	25	3	70	6	B	321534
3.09	10	25	3	70	6	B	321535
3.10	10	-	3	70	6	A	321536
3.11	10	-	3	70	6	A	321537
3.12	10	-	3	70	6	A	321538
3.13	10	-	3	70	6	A	321539
3.14	10	-	3	70	6	A	321540





P. 64



> Ø 2.97



Ref. A



Ref. B

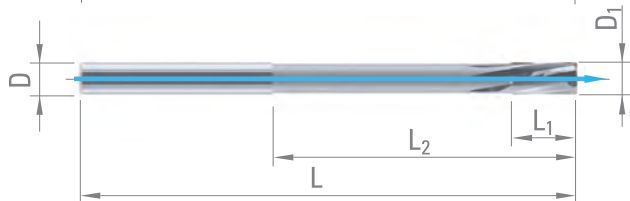

**DE STOCK
AB LAGER
A MAGAZZINO**

D _{10/+0.003}	L ₁	L ₂	D _{h5}	L	Z	Ref.	HM
3.15	10	-	3	70	6	A	321541
3.16	10	-	3	70	6	A	321542
3.17	10	-	3	70	6	A	321543
3.18	10	-	3	70	6	A	321544
3.19	10	-	3	70	6	A	321545
3.20	10	-	3	70	6	A	321546
3.21	10	-	3	70	6	A	321547
3.22	10	-	3	70	6	A	321548
3.23	10	-	3	70	6	A	321549
3.24	10	-	3	70	6	A	321550
3.25	10	-	3	70	6	A	321551
3.26	10	-	3	70	6	A	321552
3.27	10	-	3	70	6	A	321553
3.28	10	-	3	70	6	A	321554
3.29	10	-	3	70	6	A	321555
3.30	10	-	3	70	6	A	321556
3.31	10	-	3	70	6	A	321557
3.32	10	-	3	70	6	A	321558
3.33	10	-	3	70	6	A	321559
3.34	10	-	3	70	6	A	321560
3.35	10	-	3	70	6	A	321561
3.36	10	-	3	70	6	A	321562
3.37	10	-	3	70	6	A	321563
3.38	10	-	3	70	6	A	321564
3.39	10	-	3	70	6	A	321565
3.40	10	-	3	70	6	A	321566
3.41	10	-	3	70	6	A	321567
3.42	10	-	3	70	6	A	321568
3.43	10	-	3	70	6	A	321569
3.44	10	-	3	70	6	A	321570
3.45	10	-	3	70	6	A	321571
3.46	10	-	3	70	6	A	321572
3.47	10	-	3	70	6	A	321573
3.48	10	-	3	70	6	A	321574
3.49	10	-	3	70	6	A	321575
3.50	10	-	3	70	6	A	321576
3.51	10	-	3	70	6	A	321577
3.52	10	-	3	70	6	A	321578
3.53	10	-	3	70	6	A	321579
3.54	10	-	3	70	6	A	321580
3.55	10	-	3	70	6	A	321581
3.56	10	-	3	70	6	A	321582
3.57	10	-	3	70	6	A	321583
3.58	10	-	3	70	6	A	321584
3.59	10	-	3	70	6	A	321585
3.60	10	-	3	70	6	A	321586
3.61	10	-	3	70	6	A	321587

D _{10/+0.003}	L ₁	L ₂	D _{h5}	L	Z	Ref.	HM
3.62	10	-	3	70	6	A	321588
3.63	10	-	3	70	6	A	321589
3.64	10	-	3	70	6	A	321590
3.65	10	-	3	70	6	A	321591
3.66	10	-	3	70	6	A	321592
3.67	10	-	3	70	6	A	321593
3.68	10	-	3	70	6	A	321594
3.69	10	-	3	70	6	A	321595
3.70	10	-	3	70	6	A	321596
3.71	10	-	3	70	6	A	321597
3.72	10	-	3	70	6	A	321598
3.73	10	-	3	70	6	A	321599
3.74	10	-	3	70	6	A	321600
3.75	10	-	3	70	6	A	321601
3.76	10	-	3	70	6	A	321602
3.77	10	-	3	70	6	A	321603
3.78	10	-	3	70	6	A	321604
3.79	10	-	3	70	6	A	321605
3.80	10	-	3	70	6	A	321606
3.81	10	-	3	70	6	A	321607
3.82	10	-	3	70	6	A	321608
3.83	10	-	3	70	6	A	321609
3.84	10	-	3	70	6	A	321610
3.85	10	-	3	70	6	A	321611
3.86	10	-	3	70	6	A	321612
3.87	10	-	3	70	6	A	321613
3.88	10	-	3	70	6	A	321614
3.89	10	-	3	70	6	A	321615
3.90	10	-	3	70	6	A	321616
3.91	10	-	3	70	6	A	321617
3.92	10	-	3	70	6	A	321618
3.93	10	-	3	70	6	A	321619
3.94	10	-	3	70	6	A	321620
3.95	10	-	3	70	6	A	321621
3.96	10	-	3	70	6	A	321622
3.97	10	-	3	70	6	A	321623
3.98	10	-	3	70	6	A	321624
3.99	10	-	3	70	6	A	321625
4.00	10	-	3	70	6	A	321626
4.01	10	-	3	70	6	A	321627
4.02	10	-	3	70	6	A	321628
4.03	10	-	3	70	6	A	321629
4.04	10	-	3	70	6	A	321630
4.05	10	-	3	70	6	A	321631
4.06	10	-	3	70	6	A	321632
4.07	10	-	3	70	6	A	321633
4.08	10	-	3	70	6	A	321634



POLY 4007 - 4007-TC



P. 64



> Ø 2.97



Ref. A

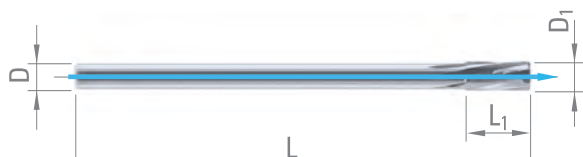

Ref. B

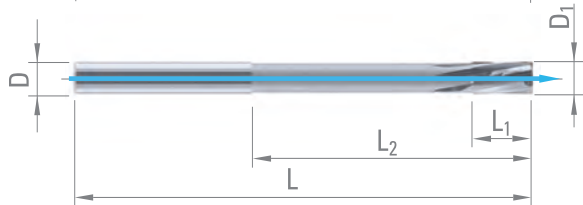

**DE STOCK
AB LAGER
A MAGAZZINO**

D _{10/+0.003}	L ₁	L ₂	D _{h5}	L	Z	Ref.	HM
4.09	10	-	3	70	6	A	321635
4.10	12	-	4	80	6	A	321636
4.11	12	-	4	80	6	A	321637
4.12	12	-	4	80	6	A	321638
4.13	12	-	4	80	6	A	321639
4.14	12	-	4	80	6	A	321640
4.15	12	-	4	80	6	A	321641
4.16	12	-	4	80	6	A	321642
4.17	12	-	4	80	6	A	321643
4.18	12	-	4	80	6	A	321644
4.19	12	-	4	80	6	A	321645
4.20	12	-	4	80	6	A	321646
4.21	12	-	4	80	6	A	321647
4.22	12	-	4	80	6	A	321648
4.23	12	-	4	80	6	A	321649
4.24	12	-	4	80	6	A	321650
4.25	12	-	4	80	6	A	321651
4.26	12	-	4	80	6	A	321652
4.27	12	-	4	80	6	A	321653
4.28	12	-	4	80	6	A	321654
4.29	12	-	4	80	6	A	321655
4.30	12	-	4	80	6	A	321656
4.31	12	-	4	80	6	A	321657
4.32	12	-	4	80	6	A	321658
4.33	12	-	4	80	6	A	321659
4.34	12	-	4	80	6	A	321660
4.35	12	-	4	80	6	A	321661
4.36	12	-	4	80	6	A	321662
4.37	12	-	4	80	6	A	321663
4.38	12	-	4	80	6	A	321664
4.39	12	-	4	80	6	A	321665
4.40	12	-	4	80	6	A	321666
4.41	12	-	4	80	6	A	321667
4.42	12	-	4	80	6	A	321668
4.43	12	-	4	80	6	A	321669
4.44	12	-	4	80	6	A	321670
4.45	12	-	4	80	6	A	321671
4.46	12	-	4	80	6	A	321672
4.47	12	-	4	80	6	A	321673
4.48	12	-	4	80	6	A	321674
4.49	12	-	4	80	6	A	321675
4.50	12	-	4	80	6	A	321676
4.51	12	-	4	80	6	A	321677
4.52	12	-	4	80	6	A	321678
4.53	12	-	4	80	6	A	321679
4.54	12	-	4	80	6	A	321680
4.55	12	-	4	80	6	A	321681

D _{10/+0.003}	L ₁	L ₂	D _{h5}	L	Z	Ref.	HM
4.56	12	-	4	80	6	A	321682
4.57	12	-	4	80	6	A	321683
4.58	12	-	4	80	6	A	321684
4.59	12	-	4	80	6	A	321685
4.60	12	-	4	80	6	A	321686
4.61	12	-	4	80	6	A	321687
4.62	12	-	4	80	6	A	321688
4.63	12	-	4	80	6	A	321689
4.64	12	-	4	80	6	A	321690
4.65	12	-	4	80	6	A	321691
4.66	12	-	4	80	6	A	321692
4.67	12	-	4	80	6	A	321693
4.68	12	-	4	80	6	A	321694
4.69	12	-	4	80	6	A	321695
4.70	12	-	4	80	6	A	321696
4.71	12	-	4	80	6	A	321697
4.72	12	-	4	80	6	A	321698
4.73	12	-	4	80	6	A	321699
4.74	12	-	4	80	6	A	321700
4.75	12	-	4	80	6	A	321701
4.76	12	-	4	80	6	A	321702
4.77	12	-	4	80	6	A	321703
4.78	12	-	4	80	6	A	321704
4.79	12	-	4	80	6	A	321705
4.80	12	-	4	80	6	A	321706
4.81	12	-	4	80	6	A	321707
4.82	12	-	4	80	6	A	321708
4.83	12	-	4	80	6	A	321709
4.84	12	-	4	80	6	A	321710
4.85	12	-	4	80	6	A	321711
4.86	12	-	4	80	6	A	321712
4.87	12	-	4	80	6	A	321713
4.88	12	-	4	80	6	A	321714
4.89	12	-	4	80	6	A	321715
4.90	12	-	4	80	6	A	321716
4.91	12	-	4	80	6	A	321717
4.92	12	-	4	80	6	A	321718
4.93	12	-	4	80	6	A	321719
4.94	12	-	4	80	6	A	321720
4.95	12	-	4	80	6	A	321721
4.96	12	-	4	80	6	A	321722
4.97	12	-	4	80	6	A	321723
4.98	12	-	4	80	6	A	321724
4.99	12	-	4	80	6	A	321725
5.00	12	-	4	80	6	A	321726
5.01	12	-	4	80	6	A	321727
5.02	12	-	4	80	6	A	321728



POLY 4007 - 4007-TC



P. 64



> Ø 2.97



Ref. A



Ref. B

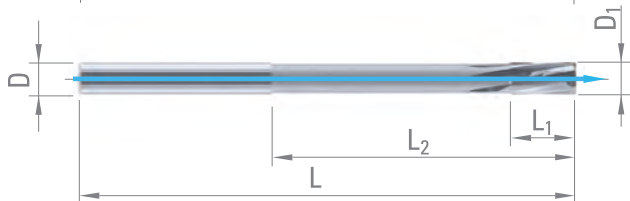

**DE STOCK
AB LAGER
A MAGAZZINO**

$D_{10/+0.003}$	L_1	L_2	D_{h5}	L	Z	Ref.	HM
5.03	12	-	4	80	6	A	321729
5.04	12	-	4	80	6	A	321730
5.05	12	-	4	80	6	A	321731
5.06	12	-	4	80	6	A	321732
5.07	12	-	4	80	6	A	321733
5.08	12	-	4	80	6	A	321734
5.09	12	-	4	80	6	A	321735
5.10	12	-	4	80	6	A	321736
5.11	12	-	4	80	6	A	321737
5.12	12	-	4	80	6	A	321738
5.13	12	-	4	80	6	A	321739
5.14	12	-	4	80	6	A	321740
5.15	12	-	4	80	6	A	321741
5.16	12	-	4	80	6	A	321742
5.17	12	-	4	80	6	A	321743
5.18	12	-	4	80	6	A	321744
5.19	12	-	4	80	6	A	321745
5.20	12	-	4	80	6	A	321746
5.21	12	-	4	80	6	A	321747
5.22	12	-	4	80	6	A	321748
5.23	12	-	4	80	6	A	321749
5.24	12	-	4	80	6	A	321750
5.25	12	-	4	80	6	A	321751
5.26	12	-	4	80	6	A	321752
5.27	12	-	4	80	6	A	321753
5.28	12	-	4	80	6	A	321754
5.29	12	-	4	80	6	A	321755
5.30	12	-	4	80	6	A	321756
5.31	12	-	4	80	6	A	321757
5.32	12	-	4	80	6	A	321758
5.33	12	-	4	80	6	A	321759
5.34	12	-	4	80	6	A	321760
5.35	12	-	4	80	6	A	321761
5.36	12	-	4	80	6	A	321762
5.37	12	-	4	80	6	A	321763
5.38	12	-	4	80	6	A	321764
5.39	12	-	4	80	6	A	321765
5.40	12	-	4	80	6	A	321766
5.41	12	-	4	80	6	A	321767
5.42	12	-	4	80	6	A	321768
5.43	12	-	4	80	6	A	321769
5.44	12	-	4	80	6	A	321770
5.45	12	-	4	80	6	A	321771
5.46	12	-	4	80	6	A	321772
5.47	12	-	4	80	6	A	321773
5.48	12	-	4	80	6	A	321774
5.49	12	-	4	80	6	A	321775

$D_{10/+0.003}$	L_1	L_2	D_{h5}	L	Z	Ref.	HM
5.50	12	-	4	80	6	A	321776
5.51	12	-	4	80	6	A	321777
5.52	12	-	4	80	6	A	321778
5.53	12	-	4	80	6	A	321779
5.54	12	-	4	80	6	A	321780
5.55	12	-	4	80	6	A	321781
5.56	12	-	4	80	6	A	321782
5.57	12	-	4	80	6	A	321783
5.58	12	-	4	80	6	A	321784
5.59	12	-	4	80	6	A	321785
5.60	12	-	4	80	6	A	321786
5.61	12	-	4	80	6	A	321787
5.62	12	-	4	80	6	A	321788
5.63	12	-	4	80	6	A	321789
5.64	12	-	4	80	6	A	321790
5.65	12	-	4	80	6	A	321791
5.66	12	-	4	80	6	A	321792
5.67	12	-	4	80	6	A	321793
5.68	12	-	4	80	6	A	321794
5.69	12	-	4	80	6	A	321795
5.70	12	-	4	80	6	A	321796
5.71	12	-	4	80	6	A	321797
5.72	12	-	4	80	6	A	321798
5.73	12	-	4	80	6	A	321799
5.74	12	-	4	80	6	A	321800
5.75	12	-	4	80	6	A	321801
5.76	12	-	4	80	6	A	321802
5.77	12	-	4	80	6	A	321803
5.78	12	-	4	80	6	A	321804
5.79	12	-	4	80	6	A	321805
5.80	12	-	4	80	6	A	321806
5.81	12	-	4	80	6	A	321807
5.82	12	-	4	80	6	A	321808
5.83	12	-	4	80	6	A	321809
5.84	12	-	4	80	6	A	321810
5.85	12	-	4	80	6	A	321811
5.86	12	-	4	80	6	A	321812
5.87	12	-	4	80	6	A	321813
5.88	12	-	4	80	6	A	321814
5.89	12	-	4	80	6	A	321815
5.90	12	-	4	80	6	A	321816
5.91	12	-	4	80	6	A	321817
5.92	12	-	4	80	6	A	321818
5.93	12	-	4	80	6	A	321819
5.94	12	-	4	80	6	A	321820
5.95	12	-	4	80	6	A	321821
5.96	12	-	4	80	6	A	321822



POLY 4007 - 4007-TC



P. 64



> Ø 2.97



Ref. A



Ref. B

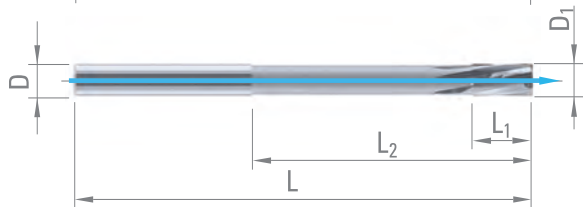

**DE STOCK
AB LAGER
A MAGAZZINO**

D _{10/+0.003}	L ₁	L ₂	D _{h5}	L	Z	Ref.	HM
5.97	12	-	4	80	6	A	321823
5.98	12	-	4	80	6	A	321824
5.99	12	-	4	80	6	A	321825
6.00	12	-	4	80	6	A	321826
6.01	12	-	4	80	6	A	321827
6.02	12	-	4	80	6	A	321828
6.03	12	-	4	80	6	A	321829
6.04	12	-	4	80	6	A	321830
6.05	12	-	4	80	6	A	321831
6.06	12	-	4	80	6	A	321832
6.07	12	-	4	80	6	A	321833
6.08	12	-	4	80	6	A	321834
6.09	12	-	4	80	6	A	321835
6.10	12	-	4	80	6	A	321836
6.11	12	-	4	80	6	A	321837
6.12	12	-	4	80	6	A	321838
6.13	12	-	4	80	6	A	321839
6.14	12	-	4	80	6	A	321840
6.15	12	-	4	80	6	A	321841
6.16	12	-	4	80	6	A	321842
6.17	12	-	4	80	6	A	321843
6.18	12	-	4	80	6	A	321844
6.19	12	-	4	80	6	A	321845
6.20	16	-	6	101	6	A	342052
6.30	16	-	6	101	6	A	342062
6.40	16	-	6	101	6	A	342072
6.50	16	-	6	101	6	A	342082
6.51	16	-	6	101	6	A	342083
6.52	16	-	6	101	6	A	342084
6.60	16	-	6	101	6	A	342092
6.70	16	-	6	101	6	A	342102
6.80	16	-	6	101	6	A	342112
6.90	16	-	6	101	6	A	342122
7.00	16	-	6	101	6	A	342132
7.01	16	-	6	101	6	A	342133
7.02	16	-	6	101	6	A	342134
7.10	16	-	6	101	6	A	342142
7.20	16	-	6	101	6	A	342152
7.30	16	-	6	101	6	A	342162
7.40	16	-	6	101	6	A	342172
7.50	16	-	6	101	6	A	342182
7.51	16	-	6	101	6	A	342183
7.52	16	-	6	101	6	A	342184
7.60	16	-	6	101	6	A	342192
7.70	16	-	6	101	6	A	342202
7.80	16	-	6	101	6	A	342212
7.90	16	-	6	101	6	A	342222

D _{10/+0.003}	L ₁	L ₂	D _{h5}	L	Z	Ref.	HM
7.98	16	-	6	101	6	A	342230
7.99	16	-	6	101	6	A	342231
8.00	16	-	6	101	6	A	342232
8.01	16	-	6	101	6	A	342233
8.02	16	-	6	101	6	A	342234
8.10	16	-	6	117	6	A	342242
8.20	16	-	6	117	6	A	342252
8.30	16	-	6	117	6	A	342262
8.40	16	-	6	117	6	A	342272
8.50	16	-	6	117	6	A	342282
8.51	16	-	6	117	6	A	342283
8.52	16	-	6	117	6	A	342284
8.70	16	-	6	117	6	A	342302
8.90	16	-	6	117	6	A	342322
9.00	16	-	6	117	6	A	342332
9.01	16	-	6	117	6	A	342333
9.02	16	-	6	117	6	A	342334
9.10	16	-	6	117	6	A	342342
9.50	16	-	6	117	6	A	342382
9.70	16	-	6	117	6	A	342402
10.00	16	-	6	117	6	A	342432
10.01	16	-	6	117	6	A	342433
10.02	19	87	10	133	6	B	200661
10.03	19	87	10	133	6	B	964048
10.10	19	87	10	133	6	B	200641
10.48	19	87	10	133	6	B	963732
10.49	19	87	10	133	6	B	963733
10.50	19	87	10	133	6	B	200642
10.51	19	87	10	133	6	B	963734
10.52	19	87	10	133	6	B	963735
10.60	19	87	10	133	6	B	200643
10.98	19	96	12	142	6	B	963736
10.99	19	96	12	142	6	B	963737
11.00	19	96	12	142	6	B	200644
11.01	19	96	12	142	6	B	963738
11.02	19	96	12	142	6	B	963739
11.48	19	96	12	142	6	B	963740
11.49	19	96	12	142	6	B	963741
11.50	19	96	12	142	6	B	200645
11.51	19	96	12	142	6	B	963742
11.52	19	96	12	142	6	B	963743
11.80	19	96	12	142	6	B	200646
11.98	19	105	12	151	6	B	963744
11.99	19	105	12	151	6	B	963745
12.00	19	105	12	151	6	B	200647
12.01	19	105	12	151	6	B	963746
12.02	19	105	12	151	6	B	200648



POLY 4261 - 4264

ALÉSOIRS FIXES COURTS BRASÉS
 GELÖTETE KURZE FEST-REIBAHLEN
 ALESATORI FISSI CORTI BRASATI

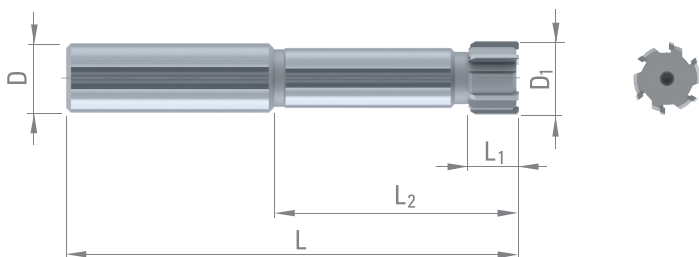

D ₁	L ₁	L ₂	D _{h6}	L	Z	HM	TiAIN	POLYCUT	C-TOP	CERMET
5.800 - 7.609	10	40	12	80	4	□	■	■	■	□
7.610 - 8.609	10	40	12	80	4	□	■	■	■	□
8.610 - 9.609	10	50	12	90	4	□	■	■	■	□
9.610 - 10.609	10	50	12	90	6	□	■	■	■	□
10.610 - 14.609	10	50	12	100	6	□	■	■	■	□
14.610 - 15.609	14	50	12	100	6	□	■	■	■	□
15.610 - 18.609	14	50	16	110	6	□	■	■	■	□
18.610 - 21.109	14	60	20	130	6	□	■	■	■	□
21.110 - 25.109	14	60	20	130	6	□	■	■	■	□
25.110 - 26.109	14	75	25	145	6	□	■	■	■	□
26.110 - 28.109	18	75	25	145	6	□	■	■	■	□
28.110 - 33.109	18	75	25	145	6	□	■	■	■	□
33.110 - 45.109	18	75	25	145	6	□	■	■	■	□
45.110 - 65.109	18	90	32	160	8	□	■	■	■	□
65.110 - 90.109	18	90	32	160	10	□	■	■	■	□
90.110 - 130.000	18	90	32	160	12	□	■	■	■	□

POLY 4261



POLY 4261-TC

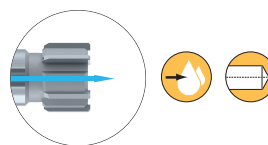

POLY 4261-FC

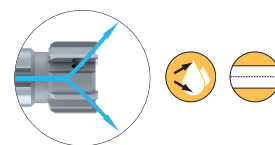

POLY 4264



POLY 4264-FC

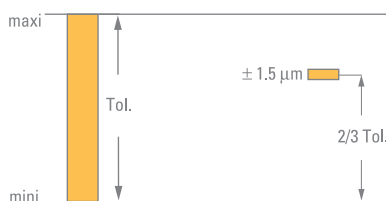
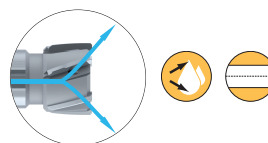

POLY 4271 - 4274

ALÉSOIRS FIXES LONGS BRASÉS
 GELÖTETE LANGE FEST-REIBAHLEN
 ALESATORI FISSI LUNGI BRASATI

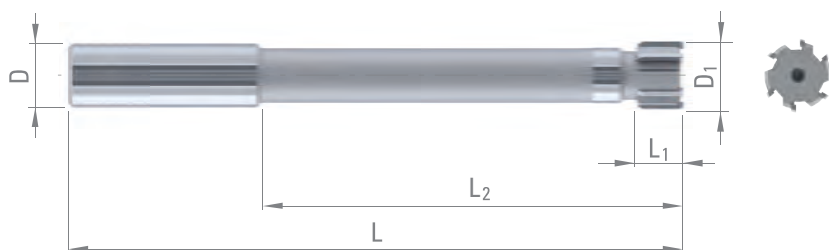

D ₁	L ₁	L ₂	D _{h6}	L	Z	HM	TiAIN	POLYCUT	C-TOP	CERMET
5.800 - 7.609	10	80	12	120	4	☐	■	■	■	☐
7.610 - 8.609	10	80	12	120	4	☐	■	■	■	☐
8.610 - 9.609	10	90	12	130	4	☐	■	■	■	☐
9.610 - 10.609	10	90	12	130	6	☐	■	■	■	☐
10.610 - 14.609	10	100	12	150	6	☐	■	■	■	☐
14.610 - 15.609	14	100	12	150	6	☐	■	■	■	☐
15.610 - 18.609	14	100	16	160	6	☐	■	■	■	☐
18.610 - 21.109	14	120	20	190	6	☐	■	■	■	☐
21.110 - 25.109	14	120	20	190	6	☐	■	■	■	☐
25.110 - 26.109	14	150	25	220	6	☐	■	■	■	☐
26.110 - 28.109	18	150	25	220	6	☐	■	■	■	☐
28.110 - 33.109	18	150	25	220	6	☐	■	■	■	☐
33.110 - 45.109	18	150	25	220	6	☐	■	■	■	☐
45.110 - 65.109	18	150	32	250	8	☐	■	■	■	☐
65.110 - 90.109	18	150	32	250	10	☐	■	■	■	☐
90.110 - 130.000	18	180	32	250	12	☐	■	■	■	☐

POLY 4271



POLY 4271-TC

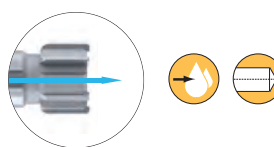

POLY 4271-FC



POLY 4274



POLY 4274-FC

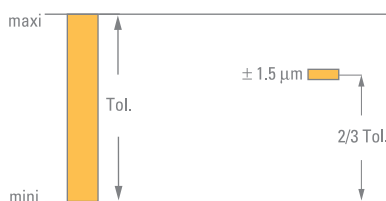

POLY 4269

ALÉSROIRS FIXES COURTS BRASÉS POUR MATIÈRES > 45 HRC
 GELÖTETE KURZE FEST-REIBAHLEN FÜR WERKSTOFFE > 45 HRC
 ALESATORI FISSI CORTI BRASATI PER MATERIALI > 45 HRC

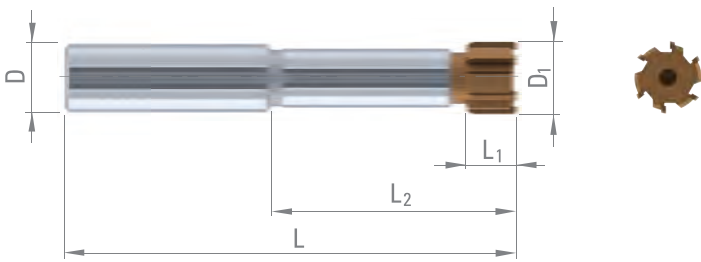

D ₁	L ₁	L ₂	D _{h6}	L	Z	C-TOP
5.800 - 7.609	10	40	12	80	4	■
7.610 - 8.609	10	40	12	80	4	■
8.610 - 9.609	10	50	12	90	4	■
9.610 - 10.609	10	50	12	90	6	■
10.610 - 14.609	10	50	12	100	6	■
14.610 - 15.609	14	50	12	100	6	■
15.610 - 18.609	14	50	16	110	6	■
18.610 - 21.109	14	60	20	130	6	■
21.110 - 25.109	14	60	20	130	6	■
25.110 - 26.109	14	75	25	145	6	■
26.110 - 28.109	18	75	25	145	6	■
28.110 - 33.109	18	75	25	145	6	■
33.110 - 45.109	18	75	25	145	6	■
45.110 - 65.109	18	90	32	160	8	■
65.110 - 90.109	18	90	32	160	10	■
90.110 - 130.000	18	90	32	160	12	■

POLY 4269



POLY 4269-TC

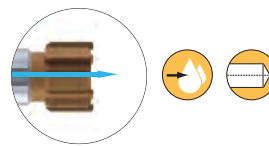

POLY 4269-FC

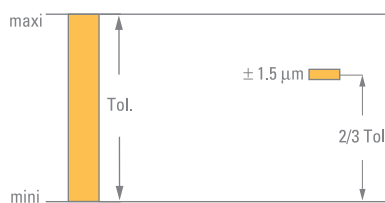
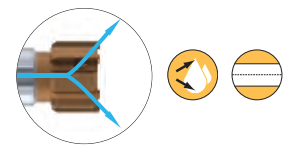

POLY 4279

ALÉSOIRS FIXES LONGS BRASÉS POUR MATIÈRES > 45 HRC
 GELÖTETE LANGE FEST-REIBAHLEN FÜR WERKSTOFFE > 45 HRC
 ALESATORI FISSI LUNGI BRASATI PER MATERIALI > 45 HRC

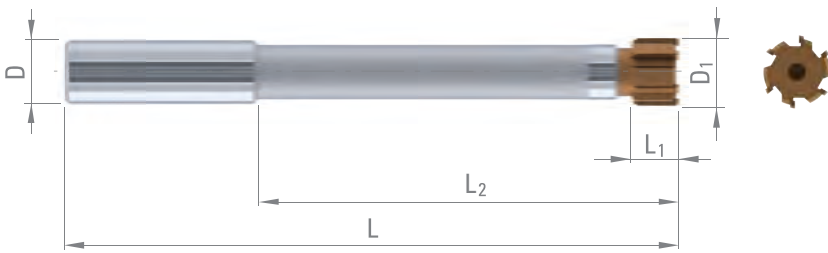

D ₁	L ₁	L ₂	D _{h6}	L	Z	C-TOP
5.800 - 7.609	10	80	12	120	4	■
7.610 - 8.609	10	80	12	120	4	■
8.610 - 9.609	10	90	12	130	4	■
9.610 - 10.609	10	90	12	130	6	■
10.610 - 14.609	10	100	12	150	6	■
14.610 - 15.609	14	100	12	150	6	■
15.610 - 18.609	14	100	16	160	6	■
18.610 - 21.109	14	120	20	190	6	■
21.110 - 25.109	14	120	20	190	6	■
25.110 - 26.109	14	150	25	220	6	■
26.110 - 28.109	18	150	25	220	6	■
28.110 - 33.109	18	150	25	220	6	■
33.110 - 45.109	18	150	25	220	6	■
45.110 - 65.109	18	180	32	250	8	■
65.110 - 90.109	18	180	32	250	10	■
90.110 - 130.000	18	180	32	250	12	■

POLY 4279

POLY 4279-TC

POLY 4279-FC

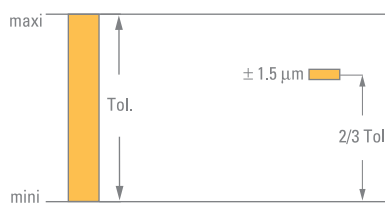
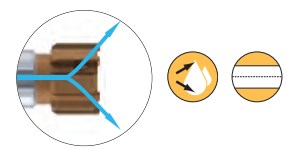
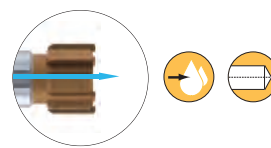



ALÉSOIRS FIXES BRASÉS SUR DEMANDE
 GELÖTETE FEST-REIBAHLEN AUF ANFRAGE
 ALESATORI FISSI BRASATI A RICHIESTA

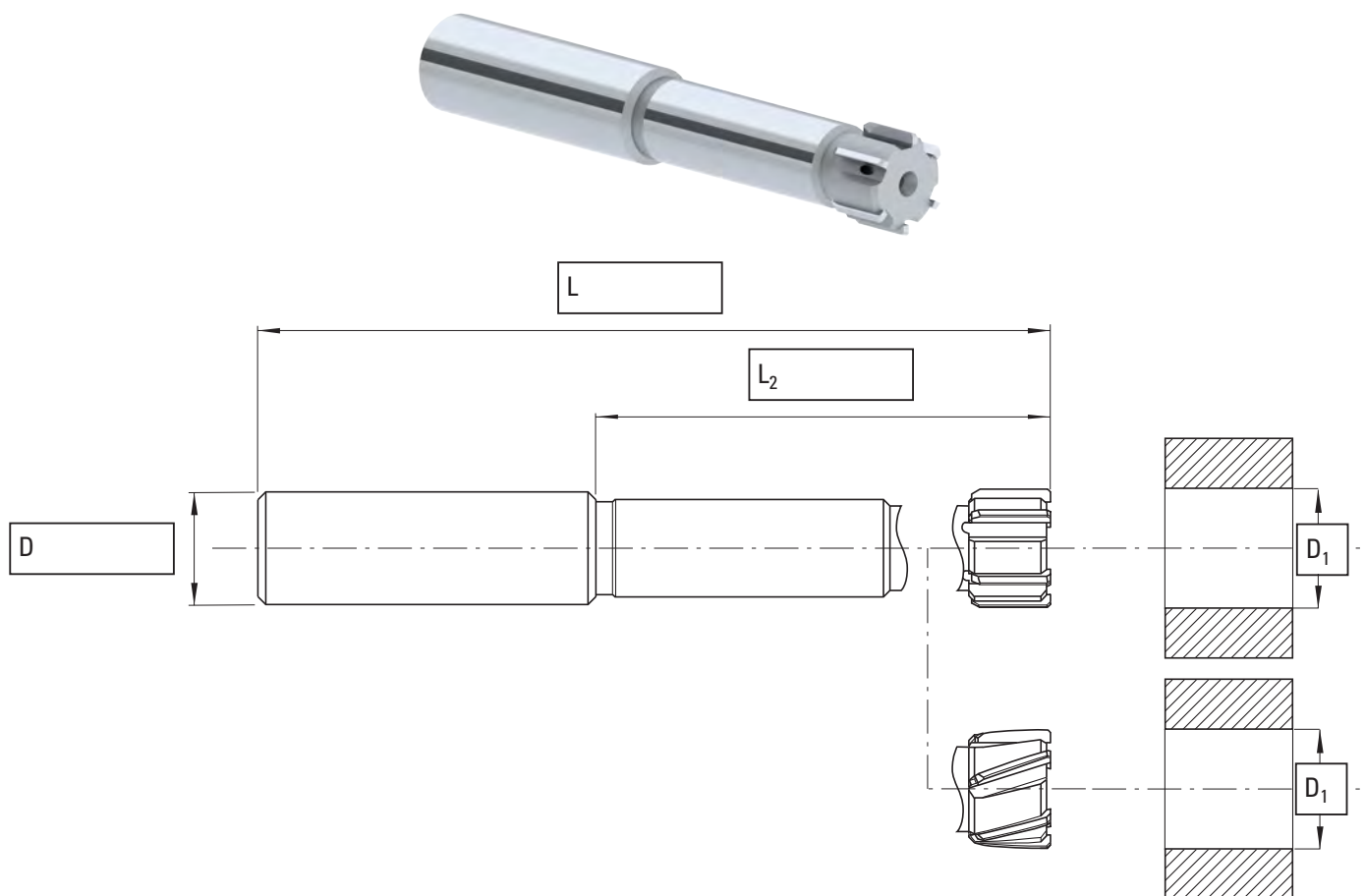

**Diamètre & tolérance
 du trou à usiner**
*Durchmesser & Toleranz
 der Bohrung*
**Diametro & tolleranza
 del foro**

D₁

Quantités
Menge
Quantità

Matière à usiner
Zu bearbeitender Werkstoff
Materiale da lavorare

Matière de coupe *Zu bearbeitender Werkstoff* **Materiale da lavorare**

HM
 VHM
 HM

HM + TiAIN
 VHM + TiAIN
 HM + TiAIN

HM + POLY-CUT
 VHM + POLY-CUT
 HM + POLY-CUT

HM + C-TOP
 VHM + C-TOP
 HM + C-TOP

CERMET

Autre:
 Andere:
 Altro: _____

Arrosage *Kühlung* **Refrigerazione**

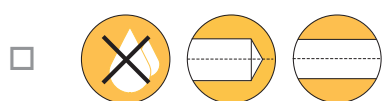



ALÉSOIRS EXPANSIBLES
NACHSTELL-REIBAHLEN
ALESATORI ESPANDIBILI



ALÉSOIRS EXPANSIBLES COURTS BRASÉS
GELÖTETE KURZE NACHSTELL-REIBAHLEN
ALESATORI ESPANDIBILI CORTI BRASATI

32

DE STOCK
AB LAGER
A MAGAZZINO



ALÉSOIRS EXPANSIBLES LONGS BRASÉS
GELÖTETE LANGE NACHSTELL-REIBAHLEN
ALESATORI ESPANDIBILI LUNGI BRASATI

34

DE STOCK
AB LAGER
A MAGAZZINO



ALÉSOIRS EXPANSIBLES COURTS BRASÉS
GELÖTETE KURZE NACHSTELL-REIBAHLEN
ALESATORI ESPANDIBILI CORTI BRASATI

36



ALÉSOIRS EXPANSIBLES LONGS BRASÉS
GELÖTETE LANGE NACHSTELL-REIBAHLEN
ALESATORI ESPANDIBILI LUNGI BRASATI

37

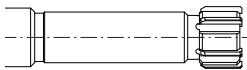

ALÉSOIRS EXPANSIBLES BRASÉS SUR DEMANDE
GELÖTETE NACHSTELL-REIBAHLEN AUF ANFRAGE
ALESATORI ESPANDIBILI BRASATI A RICHIESTA

38



TECHNOLOGIE BAGUES COUPANTES & D'EXPANSION
SCHNEIDHÜLSEN- & NACHSTELL-TECHNOLOGIE
TECNOLOGIA CORONE & DI ESPANSIONE

39

POLY 4361

ALÉSOIRS EXPANSIBLES COURTS BRASÉS
 GELÖTETE KURZE NACHSTELL-REIBAHLEN
 ALESATORI ESPANDIBILI CORTI BRASATI



P. 66

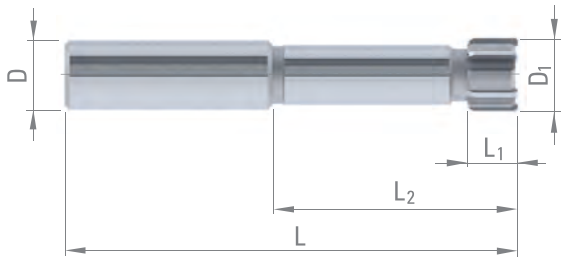
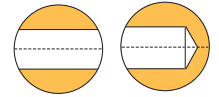

**DE STOCK
 AB LAGER
 A MAGAZZINO**

POLY 4361

POLY 4361-TC

POLY 4361-FC



D nom.
H7

D₁
± 1.5µm

L₁

L₂

D_{h6}

L

Z

POLY

HM

TAIN

CERMET

6.00	(6.006)	10	40	12	80	4	4361	61859	965576	963287
							4361-TC	61883	341107	964213
							4361-FC	326753	955517	955527
7.00	(7.007)	10	40	12	80	4	4361	63863	341096	341122
							4361-TC	341082	341108	964215
							4361-FC	977363	955518	955528
8.00	(8.007)	10	40	12	80	4	4361	61860	341097	61594
							4361-TC	61884	958621	62263
							4361-FC	966766	955519	955529
9.00	(9.007)	10	50	12	90	4	4361	954994	341098	341123
							4361-TC	974647	341109	61671
							4361-FC	969137	955520	955530
10.00	(10.007)	10	50	12	100	6	4361	61666	987470	971287
							4361-TC	61885	985270	305651
							4361-FC	970436	955521	955531
11.00	(11.009)	10	50	12	100	6	4361	953002	341099	341124
							4361-TC	341083	341110	952860
							4361-FC	341089	982623	957205
12.00	(12.009)	10	50	12	100	6	4361	61862	953717	956390
							4361-TC	61886	957400	61823
							4361-FC	961924	955522	955532
13.00	(13.009)	10	50	12	100	6	4361	953441	953899	341125
							4361-TC	951466	62899	951704
							4361-FC	956383	994806	341139
14.00	(14.009)	10	50	12	100	6	4361	61709	950932	341126
							4361-TC	61045	957939	64881
							4361-FC	965308	955523	955533
15.00	(15.009)	14	50	12	100	6	4361	952323	953408	66609
							4361-TC	955048	341111	62055
							4361-FC	964856	341118	961253

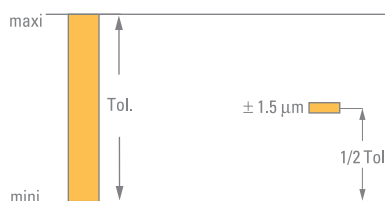

P. 73



POLY 4361



P. 66

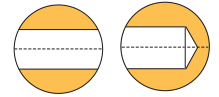

**DE STOCK
AB LAGER
A MAGAZZINO**

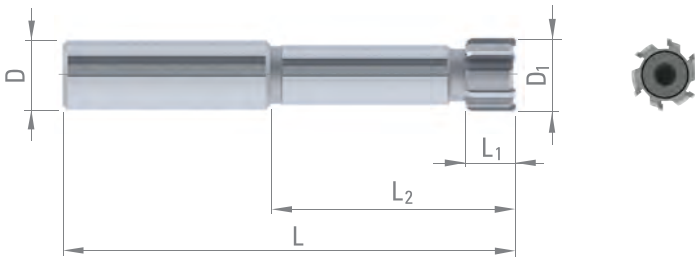

POLY 4361

POLY 4361-TC

POLY 4361-FC



D nom.
H7

D₁
± 1.5 μm

L₁

L₂

D_{h6}

L

Z

POLY

HM

TAIN

CERMET

D nom. H7	D ₁ ± 1.5 μm	L ₁	L ₂	D _{h6}	L	Z	POLY	HM	TAIN	CERMET
16.00	(16.009)	14	50	16	100	6	4361	61863	953900	990911
							4361-TC	61044	341112	60455
							4361-FC	959763	955524	955534
17.00	(17.010)	14	50	16	110	6	4361	67322	341100	341127
							4361-TC	320133	308083	341132
							4361-FC	341090	964572	959907
18.00	(18.010)	14	50	16	110	6	4361	61864	341101	965018
							4361-TC	61887	341113	341133
							4361-FC	964631	955525	955535
19.00	(19.010)	14	60	20	130	6	4361	971893	341102	341128
							4361-TC	341084	341114	341134
							4361-FC	341091	969769	985097
20.00	(20.010)	14	60	20	130	6	4361	61866	341103	965020
							4361-TC	61888	65708	341135
							4361-FC	965283	955526	955536
21.00	(21.010)	14	60	20	130	6	4361	959277	341104	341129
							4361-TC	341085	341115	341136
							4361-FC	983187	341119	959112
22.00	(22.010)	14	60	20	130	6	4361	61867	953901	965019
							4361-TC	341086	341116	341137
							4361-FC	341093	959097	965586
23.00	(23.010)	14	60	20	130	6	4361	956588	341105	341130
							4361-TC	341087	341117	341138
							4361-FC	341094	341120	341140
24.00	(24.010)	14	60	20	130	6	4361	61868	341106	341131
							4361-TC	341088	968505	969504
							4361-FC	341095	341121	962965

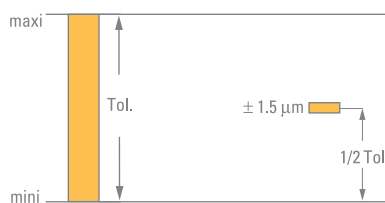

P. 73



POLY 4371



P. 66

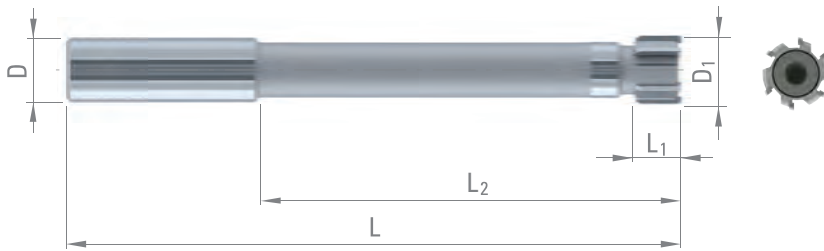
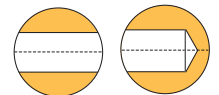

POLY 4371

POLY 4371-TC

POLY 4371-FC



D nom.
H7

D₁
± 1.5 μm

L₁

L₂

D_{h6}

L

Z

POLY

HM

TAIN

CERMET

6.00	(6.006)	10	80	12	120	4	4371	61869	341156	341186
							4371-TC	958107	965969	341204
							4371-FC	976190	955537	955547
7.00	(7.007)	10	80	12	120	4	4371	950528	341157	341187
							4371-TC	968331	341166	341205
							4371-FC	956371	955538	955548
8.00	(8.007)	10	80	12	120	4	4371	61870	341158	341188
							4371-TC	341141	341167	967206
							4371-FC	973938	955539	955549
9.00	(9.007)	10	90	12	130	4	4371	954860	341159	341189
							4371-TC	950120	341168	341206
							4371-FC	976838	955540	955550
10.00	(10.007)	10	90	12	130	6	4371	61871	310374	341190
							4371-TC	341142	341169	341207
							4371-FC	962768	955541	955551
11.00	(11.009)	10	100	12	150	6	4371	972464	982208	341191
							4371-TC	341143	341170	341208
							4371-FC	312249	959071	341221
12.00	(12.009)	10	100	12	150	6	4371	61872	310375	341192
							4371-TC	962624	341171	341209
							4371-FC	986143	955542	955552
13.00	(13.009)	10	100	12	150	6	4371	952545	341160	341193
							4371-TC	341144	341172	341210
							4371-FC	972342	977697	341222
14.00	(14.009)	10	100	12	150	6	4371	61873	310950	965516
							4371-TC	341145	341173	341211
							4371-FC	964796	955543	955553
15.00	(15.009)	14	100	12	150	6	4371	64404	304409	341194
							4371-TC	341146	341174	341212
							4371-FC	965648	976749	341223

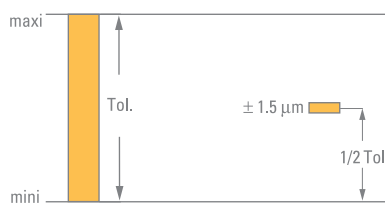

P. 73



POLY 4371



P. 66

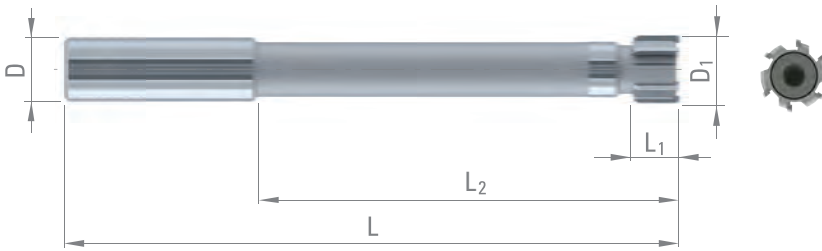
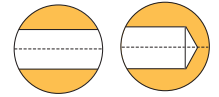

**DE STOCK
AB LAGER
A MAGAZZINO**

POLY 4371

POLY 4371-TC

POLY 4371-FC



D nom.
H7

D₁
± 1.5 μm

L₁

L₂

D_{h6}

L

Z

POLY

HM

TAIN

CERMET

D nom. H7	D ₁ ± 1.5 μm	L ₁	L ₂	D _{h6}	L	Z	POLY	HM	TAIN	CERMET
16.00	(16.009)	14	100	16	160	6	4371	61874	964387	341195
							4371-TC	977762	341175	341213
							4371-FC	982330	955544	955554
17.00	(17.010)	14	100	16	160	6	4371	960993	59895	341196
							4371-TC	341147	341176	341214
							4371-FC	341152	341184	341224
18.00	(18.010)	14	100	16	160	6	4371	61875	310376	341197
							4371-TC	961483	341177	341215
							4371-FC	962767	955545	955555
19.00	(19.010)	14	120	20	190	6	4371	66588	341161	341198
							4371-TC	319972	341178	320656
							4371-FC	955676	967797	341225
20.00	(20.010)	14	120	20	190	6	4371	61876	341162	341199
							4371-TC	400483	341179	341216
							4371-FC	341153	955546	955556
21.00	(21.010)	14	120	20	190	6	4371	334784	341163	341200
							4371-TC	341148	341180	341217
							4371-FC	994332	310771	983957
22.00	(22.010)	14	120	20	190	6	4371	963583	964388	341201
							4371-TC	341149	341181	341218
							4371-FC	341154	965966	341226
23.00	(23.010)	14	120	20	190	6	4371	963174	341164	341202
							4371-TC	341150	341182	341219
							4371-FC	962757	310773	341227
24.00	(24.010)	14	120	20	190	6	4371	62827	341165	341203
							4371-TC	341151	341183	341220
							4371-FC	341155	341185	341228

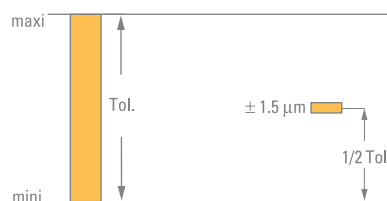

P. 73



POLY 4361 - 4364

ALÉSOIRS EXPANSIBLES COURTS BRASÉS
 GELÖTETE KURZE NACHSTELL-REIBAHLEN
 ALESATORI ESPANDIBILI CORTI BRASATI

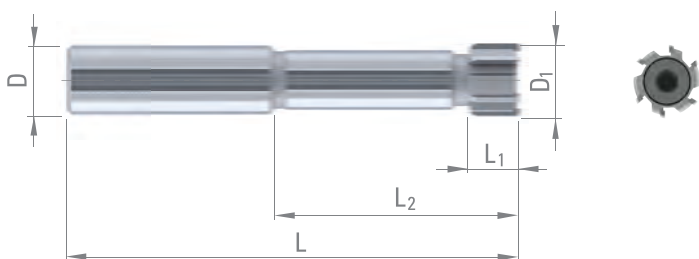

D ₁	L ₁	L ₂	D _{h6}	L	Z	HM	TiAIN	POLYCUT	C-TOP	CERMET
5.800 - 7.609	10	40	12	80	4	☐	■	■	■	☐
7.610 - 8.609	10	40	12	80	4	☐	■	■	■	☐
8.610 - 9.609	10	50	12	90	4	☐	■	■	■	☐
9.610 - 10.609	10	50	12	90	6	☐	■	■	■	☐
10.610 - 14.609	10	50	12	100	6	☐	■	■	■	☐
14.610 - 15.609	14	50	12	100	6	☐	■	■	■	☐
15.610 - 18.609	14	50	16	110	6	☐	■	■	■	☐
18.610 - 21.109	14	60	20	130	6	☐	■	■	■	☐
21.110 - 25.109	14	60	20	130	6	☐	■	■	■	☐
25.110 - 26.109	14	75	25	145	6	☐	■	■	■	☐
26.110 - 28.109	18	75	25	145	6	☐	■	■	■	☐
28.110 - 45.109	18	75	25	145	6	☐	■	■	■	☐
45.110 - 55.000	18	90	32	160	8	☐	■	■	■	☐

De Ø 55 à Ø 130 sur demande
 Von Ø 55 bis Ø 130 auf Anfrage
 Da Ø 55 a Ø 130 a richiesta



POLY 4361



POLY 4361-TC

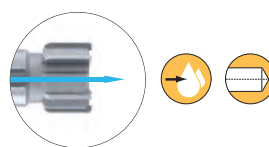

POLY 4361-FC

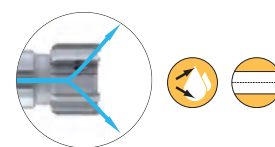

POLY 4364



POLY 4364-FC

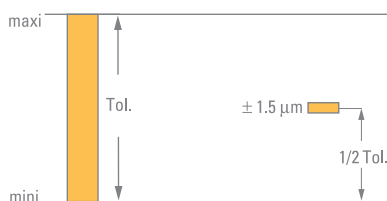

POLY 4371 - 4374

ALÉSOIRS EXPANSIBLES LONGS BRASÉS
 GELÖTETE LANGE NACHSTELL-REIBAHLEN
 ALESATORI ESPANDIBILI LUNGHY BRASATI

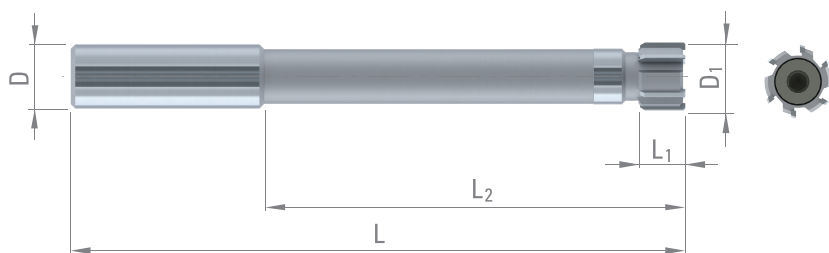

D ₁	L ₁	L ₂	D _{h6}	L	Z	HM	TiAIN	POLYCUT	C-TOP	CERMET
5.800 - 7.609	10	80	12	120	4	☐	■	■	■	☐
7.610 - 8.609	10	80	12	120	4	☐	■	■	■	☐
8.610 - 9.609	10	90	12	130	4	☐	■	■	■	☐
9.610 - 10.609	10	90	12	130	6	☐	■	■	■	☐
10.610 - 14.609	10	100	12	150	6	☐	■	■	■	☐
14.610 - 15.609	14	100	12	150	6	☐	■	■	■	☐
15.610 - 18.609	14	100	16	160	6	☐	■	■	■	☐
18.610 - 21.109	14	120	20	190	6	☐	■	■	■	☐
21.110 - 25.109	14	120	20	190	6	☐	■	■	■	☐
25.110 - 26.109	14	150	25	220	6	☐	■	■	■	☐
26.110 - 28.109	18	150	25	220	6	☐	■	■	■	☐
28.110 - 45.109	18	150	25	220	6	☐	■	■	■	☐
45.110 - 55.000	18	180	32	250	8	☐	■	■	■	☐

De Ø 55 à Ø 130 sur demande
 Von Ø 55 bis Ø 130 auf Anfrage
 Da Ø 55 a Ø 130 a richiesta



P. 39

POLY 4371



POLY 4371-TC

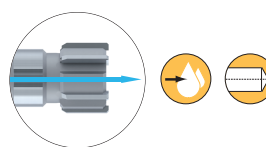

POLY 4371-FC

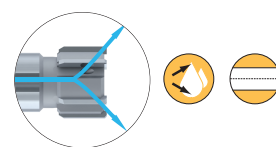

POLY 4374



POLY 4374-FC

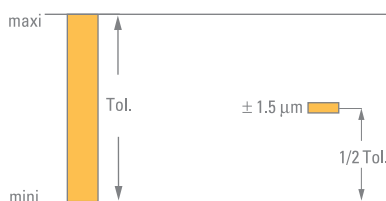
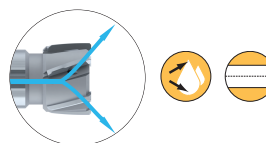

P. 73



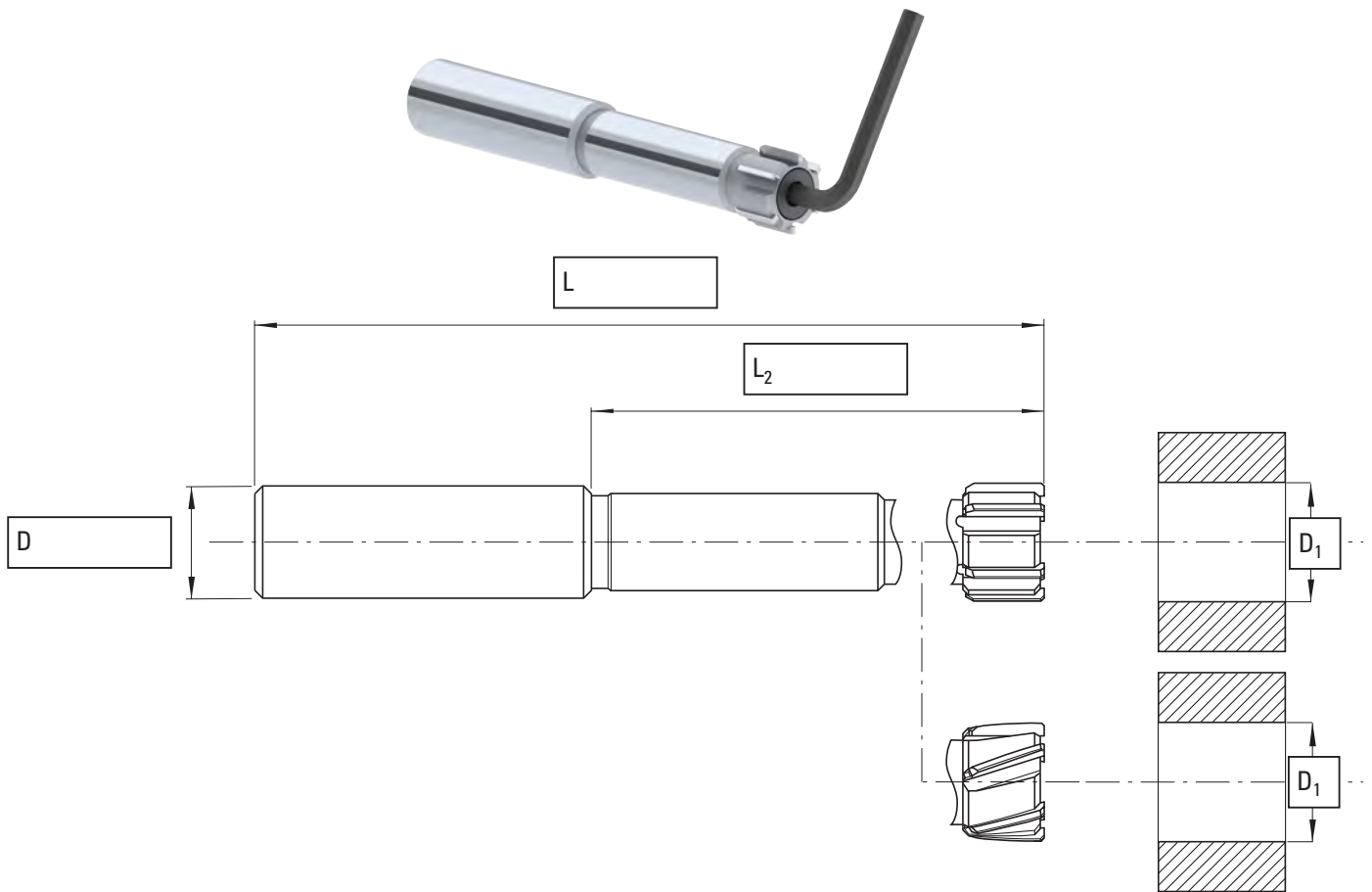

Quantités
 Menge
 Quantità

Diamètre & tolérance
 du trou à usiner
 Durchmesser & Toleranz
 der Bohrung
 Diametro & tolleranza
 del foro

D₁

Matière à usiner
 Zu bearbeitender Werkstoff
 Materiale da lavorare

Matière de coupe *Zu bearbeitender Werkstoff* Materiale da lavorare

HM
 VHM
 HM

HM + C-TOP
 VHM + C-TOP
 HM + C-TOP

HM + TiAIN
 VHM + TiAIN
 HM + TiAIN

CERMET

HM + POLY CUT
 VHM + POLY CUT
 HM + POLY CUT

Autre:
 Andere:
 Altro: _____

Arrosage *Kühlung* Refrigerazione

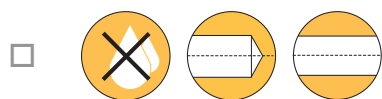



Système à bagues coupantes expansibles de Ø 55 à Ø 130 sur demande
System Nachstell-Schneidhülsen von Ø 55 bis Ø 130 auf Anfrage
Systema a corone espandibili da Ø 55 a Ø 130 su richiesta



TECHNOLOGIE D'EXPANSION
NACHSTELL-TECHNOLOGIE
TECNOLOGIA DI ESPANSIONE

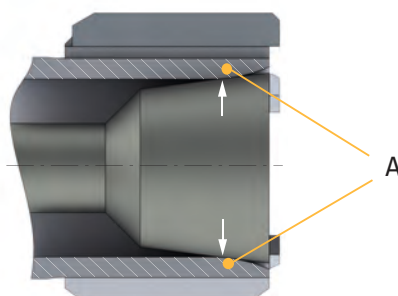

Système d'expansion

Avantages des alésoirs expansibles:

- Réglage au milieu de la tolérance pour chaque application
- Compensation de l'usure, donc durée de vie plus élevée

Le système d'expansion POLYTOOL est appliqué aux alésoirs, aux têtes et aux bagues coupantes expansibles. Un cône introduit dans une pièce convexe permet de la déformer. Grâce au cercle de contact (A) parfaitement défini, le réglage de l'alésoir est très précis.

Même après plusieurs expansions, la précision et les performances de l'alésoir restent inchangées.

Nachstell-System

Vorteile der Nachstell-Reibahlen:

- Anpassung von Toleranzen an die gegebenen Einsatzbedingungen
- Kompensation der Abnutzung, dadurch eine Verlängerung der Standzeit

Das POLYTOOL-Nachstell-System wird bei Nachstell-Reibahlen an den Köpfen und an den Schneidhülsen angewendet.

Ein konisches Teil, das an ein konvexes Gegenstück angelegt wird, macht es möglich dieses Teil zu verformen. Durch die eindeutig definierte Berührungs-Stelle (Druckpunkt A), können wir eine präzise Nachstellung der Reibahle erreichen.

Auch nach mehrmaligem Nachstellen, bleibt die Geometrie der Reibahle erhalten.

Sistema di espansione

Vantaggi degli alesatori espandibili:

- Registrazione a metà della tolleranza per ogni applicazione
- Compensazione dell'usura, quindi vita utensile più elevata

Il sistema di espansione POLYTOOL è applicato agli alesatori, alle testine ed alle corone espandibili.

Un cono introdotto in una parte convessa ne permette la deformazione.

Grazie al cerchio di contatto (A) perfettamente definito, la registrazione dell'alesatore è molto precisa.

Anche dopo parecchie espansioni, la precisione e le prestazioni dell'alesatore rimangono inalterate.



TÊTES FIXES & EXPANSIBLES
FEST-KÖPFE & NACHSTELL-KÖPFE
TESTINE FISSE & ESPANDIBILI



TÊTES FIXES BRASÉES
GELÖTETE FEST-KÖPFE
TESTINE FISSE BRASATE

42



TÊTES EXPANSIBLES BRASÉES
GELÖTETE NACHSTELL-KÖPFE
TESTINE ESPANDIBILI BRASATE

44



TÊTES CARBURE MONOBLOC
VHM-KÖPFE
TESTINE IN METALLO DURO INTEGRALE

46



TASSEAUX POUR TÊTES
HALTER FÜR KÖPFE
MANDRINI PER TESTINE

48



ADAPTATEURS POUR TÊTES
ADAPTER FÜR KÖPFE
ADATTATORI PER TESTINE

49

POLY 4401 - 4404

TÊTES FIXES BRASÉES
 GELÖTETE FEST-KÖPFE
 TESTINE FISSE BRASATE



POLY 4401

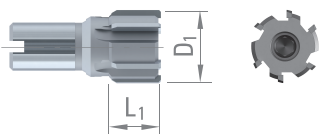

POLY 4404

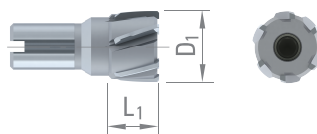

D ₁	L ₁	Z	HM	TiAIN	POLYCUT	C-TOP	CERMET
9.600 - 11.609	10	6	☐	■	■	■	☐
11.610 - 12.609	10	6	☐	■	■	■	☐
12.610 - 14.609	10	6	☐	■	■	■	☐
14.610 - 15.609	14	6	☐	■	■	■	☐
15.610 - 18.609	14	6	☐	■	■	■	☐
18.610 - 23.109	14	6	☐	■	■	■	☐
23.110 - 26.109	14	6	☐	■	■	■	☐
26.110 - 28.109	18	6	☐	■	■	■	☐
28.110 - 31.109	18	6	☐	■	■	■	☐
31.110 - 45.109	18	6	☐	■	■	■	☐
45.110 - 55.000	18	8	☐	■	■	■	☐

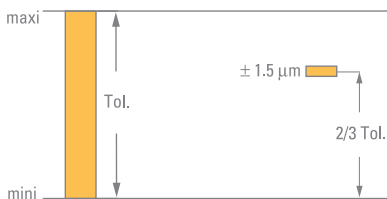

POLY 8002 / POLY 8004 P.48

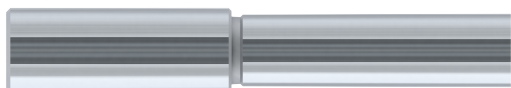

POLY 4401

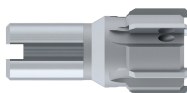

POLY 6046



POLY 4404

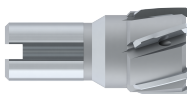

POLY 6046



POLY 8002 / POLY 8004 P.48



POLY 4401

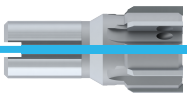

POLY 6046-TC



POLY 4401-FC

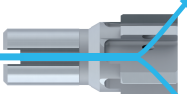

POLY 6046-FC



POLY 4404-FC

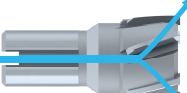

POLY 6046-FC



POLY 6046

VIS POUR TÊTES FIXES BRASÉES
 SCHRAUBEN FÜR GELÖTETE FEST-KÖPFE
 VITI PER TESTINE FISSE BRASATE



POLY 6046



POLY 6046-TC



POLY 6046-FC

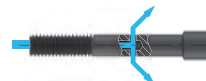

D ₁	Art.	Art.	Art.	M
9.600 - 12.609	400095	400136	962691	3 x 0.35
12.610 - 15.609	400096	400137	961366	4 x 0.50
15.610 - 18.609	400097	400138	962725	5 x 0.50
18.610 - 23.109	400098	400139	963091	6 x 0.50
23.110 - 31.109	400099	400140	962423	8 x 0.75
31.110 - 55.000	400100	400141	962225	12 x 0.75

POLY 4501 - 4504

TÊTES EXPANSIBLES BRASÉES
 GELÖTETE NACHSTELL-KÖPFE
 TESTINE ESPANDIBILI BRASATE



POLY 4501

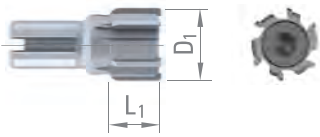

POLY 4504

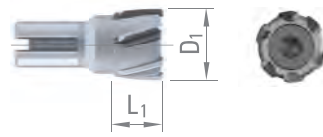

D ₁	L ₁	Z	HM	TiAIN	POLYCUT	C-TOP	CERMET
9.600 - 11.609	10	6	☐	■	■	■	☐
11.610 - 12.609	10	6	☐	■	■	■	☐
12.610 - 14.609	10	6	☐	■	■	■	☐
14.610 - 15.609	14	6	☐	■	■	■	☐
15.610 - 18.609	14	6	☐	■	■	■	☐
18.610 - 23.109	14	6	☐	■	■	■	☐
23.110 - 25.109	14	6	☐	■	■	■	☐
26.110 - 28.109	18	6	☐	■	■	■	☐
28.110 - 31.109	18	6	☐	■	■	■	☐
31.110 - 45.109	18	6	☐	■	■	■	☐
45.110 - 55.000	18		☐	■	■	■	☐

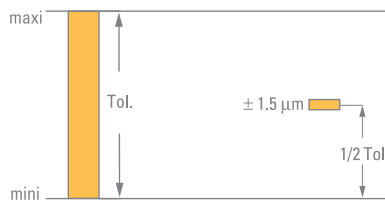

POLY 8002 / POLY 8004

P.48

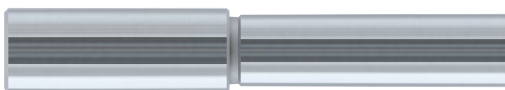

POLY 4501



POLY 6048

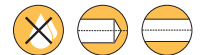

POLY 4504



POLY 6048



POLY 8002 / POLY 8004

P.48

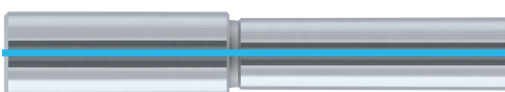

POLY 4501



POLY 6048-TC



POLY 4501-FC



POLY 6048-FC



POLY 4504-FC



POLY 6048-FC



POLY 6048

VIS POUR TÊTES EXPANSIBLES BRASÉES
 SCHRAUBEN FÜR GELÖTETE NACHSTELL-KÖPFE
 VITI PER TESTINE ESPANDIBILI BRASATE



POLY 6048



POLY 6048-TC



POLY 6048-FC



D ₁	Art.	Art.	Art.	M
9.600 - 10.609	400142	400169	954590	3 x 0.35
10.610 - 11.609	400143	400170	954593	3 x 0.35
11.610 - 14.609	400144	400171	954594	3 x 0.35
12.610 - 13.609	400145	400172	954595	4 x 0.50
13.610 - 14.609	400146	400173	954596	4 x 0.50
14.610 - 15.609	400147	400174	954597	4 x 0.50
15.610 - 16.609	400148	400175	954598	5 x 0.50
16.610 - 17.609	400149	400176	954599	5 x 0.50
17.610 - 18.609	400150	400177	954600	5 x 0.50
18.610 - 19.109	400151	400178	954601	6 x 0.50
19.110 - 20.109	400152	400179	954602	6 x 0.50
20.110 - 21.109	400153	400180	954603	6 x 0.50
21.110 - 22.109	400154	400181	954604	6 x 0.50
22.110 - 23.109	400155	400182	954605	6 x 0.50
23.110 - 24.109	400156	400183	954606	8 x 0.75
24.110 - 25.109	400157	400184	954607	8 x 0.75
25.110 - 26.109	400158	400185	954608	8 x 0.75
26.110 - 27.109	400159	400186	954609	8 x 0.75
27.110 - 28.109	400160	400187	954610	8 x 0.75
28.110 - 29.109	401203	401202	954611	8 x 0.75
29.110 - 31.109	400161	400188	954612	8 x 0.75
31.110 - 33.109	400162	400189	954613	12 x 0.75
33.110 - 35.109	400163	400190	954614	12 x 0.75
35.110 - 37.109	400164	400191	954615	12 x 0.75
37.110 - 39.109	400165	400192	954616	12 x 0.75
39.110 - 41.109	400166	400193	954617	12 x 0.75
41.110 - 43.109	400167	400194	954618	12 x 0.75
43.110 - 45.000	400168	400195	954620	12 x 0.75

POLY 4411-FC - 4414-FC

TÊTES CARBURE MONOBLOC
VHM-KÖPFE
TESTINE IN METALLO DURO INTEGRALE



POLY 4411-FC

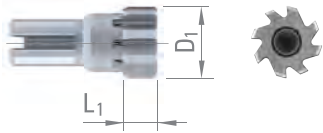

POLY 4414-FC

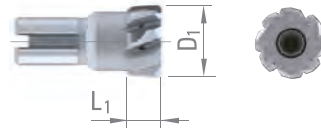

D ₁	L ₁	Z	HM	TiAIN	POLYCUT	C-TOP
9.600 - 11.609	9.7	6	<input type="checkbox"/>	<input checked="" type="checkbox"/>	<input checked="" type="checkbox"/>	<input checked="" type="checkbox"/>
11.610 - 12.609	9.7	6	<input type="checkbox"/>	<input checked="" type="checkbox"/>	<input checked="" type="checkbox"/>	<input checked="" type="checkbox"/>
12.610 - 14.609	9.7	6	<input type="checkbox"/>	<input checked="" type="checkbox"/>	<input checked="" type="checkbox"/>	<input checked="" type="checkbox"/>
14.610 - 18.609	9.7	6	<input type="checkbox"/>	<input checked="" type="checkbox"/>	<input checked="" type="checkbox"/>	<input checked="" type="checkbox"/>
18.610 - 23.109	9.7	8	<input type="checkbox"/>	<input checked="" type="checkbox"/>	<input checked="" type="checkbox"/>	<input checked="" type="checkbox"/>
23.110 - 26.109	9.7	8	<input type="checkbox"/>	<input checked="" type="checkbox"/>	<input checked="" type="checkbox"/>	<input checked="" type="checkbox"/>
26.110 - 28.109	9.7	8	<input type="checkbox"/>	<input checked="" type="checkbox"/>	<input checked="" type="checkbox"/>	<input checked="" type="checkbox"/>
28.110 - 31.109	9.7	8	<input type="checkbox"/>	<input checked="" type="checkbox"/>	<input checked="" type="checkbox"/>	<input checked="" type="checkbox"/>
31.110 - 45.000	9.7	8	<input type="checkbox"/>	<input checked="" type="checkbox"/>	<input checked="" type="checkbox"/>	<input checked="" type="checkbox"/>

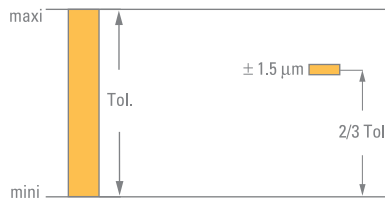

POLY 8002 / POLY 8004 P.48



POLY 4411-FC



POLY 6046

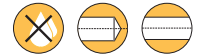

POLY 4414-FC



POLY 6046



POLY 8002 / POLY 8004 P.48

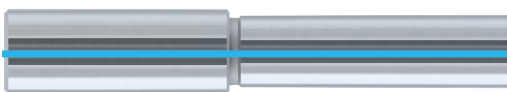

POLY 4411-FC



POLY 6046-TC



POLY 4411-FC



POLY 6046-FC



POLY 4414-FC



POLY 6046-FC



POLY 6046

VIS POUR TÊTES CARBURE MONOBLOC

SCHRAUBEN FÜR VHM-KÖPFE

VITI PER TESTINE FISSE IN METALLO DURO INTEGRALE



POLY 6046



POLY 6046-TC



POLY 6046-FC

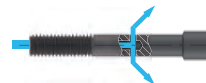

D ₁	Art.	Art.	Art.	M
9.600 - 12.609	400095	400136	962691	3 x 0.35
12.610 - 14.609	400096	400137	961366	4 x 0.50
14.610 - 18.609	400097	400138	962725	5 x 0.50
18.610 - 23.109	400098	400139	963091	6 x 0.50
23.110 - 31.109	400099	400140	962423	8 x 0.75
31.110 - 45.000	400100	400141	962225	12 x 0.75

POLY 8002

TASSEaux COURTS POUR TÊTES

KURZE HALTER FÜR KÖPFE

MANDRINI CORTI PER TESTINE FISSE ED ESPANDIBILI

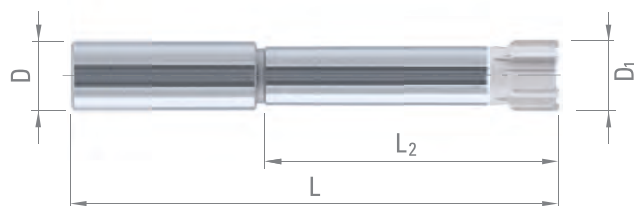

D ₁	L ₂	D _{h6}	L	Art.
9.600 - 12.609	55	12	100	955635
12.610 - 15.609	70	16	118	955636
15.610 - 18.609	71	20	121	955637
18.610 - 23.109	90	20	140	955638
23.110 - 31.109	110	25	166	955639
31.110 - 45.000	115	25	171	955791

Vis d'expansion ou de fixation livrée séparément

Nachstellschraube oder Befestigungsschraube separat bestellen

Vite a espansione o di fissaggio consegnata separatamente

POLY 8004

TASSEaux LONGS POUR TÊTES

LANGE HALTER FÜR KÖPFE

MANDRINI LUNGHI PER TESTINE FISSE ED ESPANDIBILI

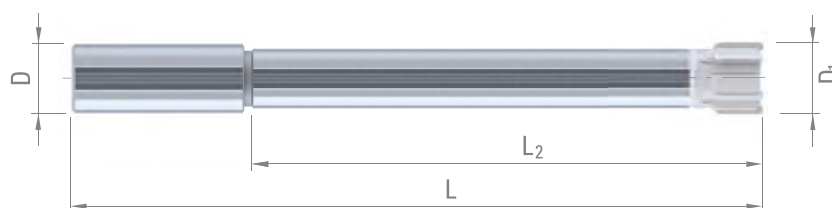

D ₁	L ₂	D _{h6}	L	Art.
9.600 - 12.609	100	12	145	955641
12.610 - 15.609	110	16	158	955642
15.610 - 18.609	130	20	180	955643
18.610 - 23.109	150	20	200	955644
23.110 - 31.109	160	25	215	955645
31.110 - 45.000	160	25	215	955969

Vis d'expansion ou de fixation livrée séparément

Nachstellschraube oder Befestigungsschraube separat bestellen

Vite a espansione o di fissaggio consegnata separatamente

ADAPTATEURS POUR TÊTES

ADAPTER FÜR KÖPFE

ADATTATORI PER TESTINE FISSE ED ESPANDIBILI



P. 72

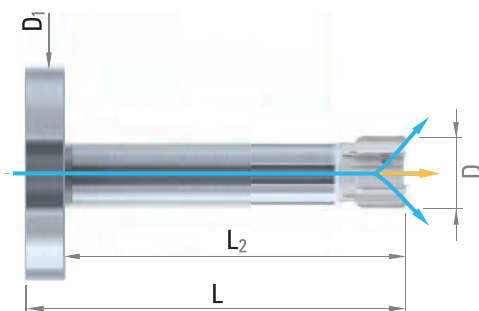

D	D ₁	L	L ₂	Art.
9.600 - 12.609	40	69	60	401222
12.610 - 15.609	40	84	75	401223
15.610 - 18.609	60	86	75	401224
18.610 - 23.109	60	106	95	401225
23.110 - 31.109	71	129	115	401226
31.110 - 45.000	71	134	120	401227
9.600 - 12.609	71	119	105	401228
12.610 - 15.609	71	129	115	401229
15.610 - 18.609	71	149	135	401230
18.610 - 23.109	71	169	155	401231
23.110 - 31.109	71	179	165	401232
31.110 - 45.000	71	179	165	401233

Vis d'expansion ou de fixation livrée séparément

Nachstellschraube oder Befestigungsschraube separat bestellen

Vite a espansione o di fissaggio consegnata separatamente

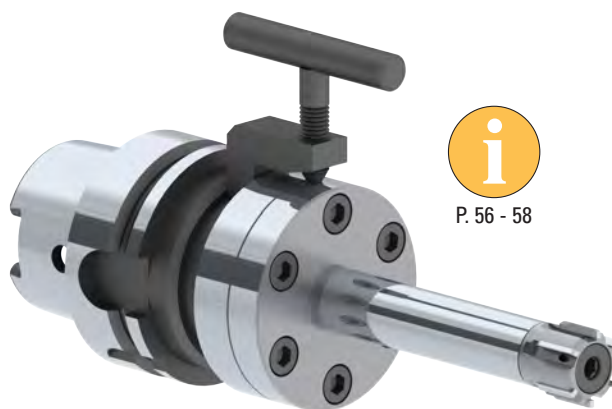

P. 56 - 58

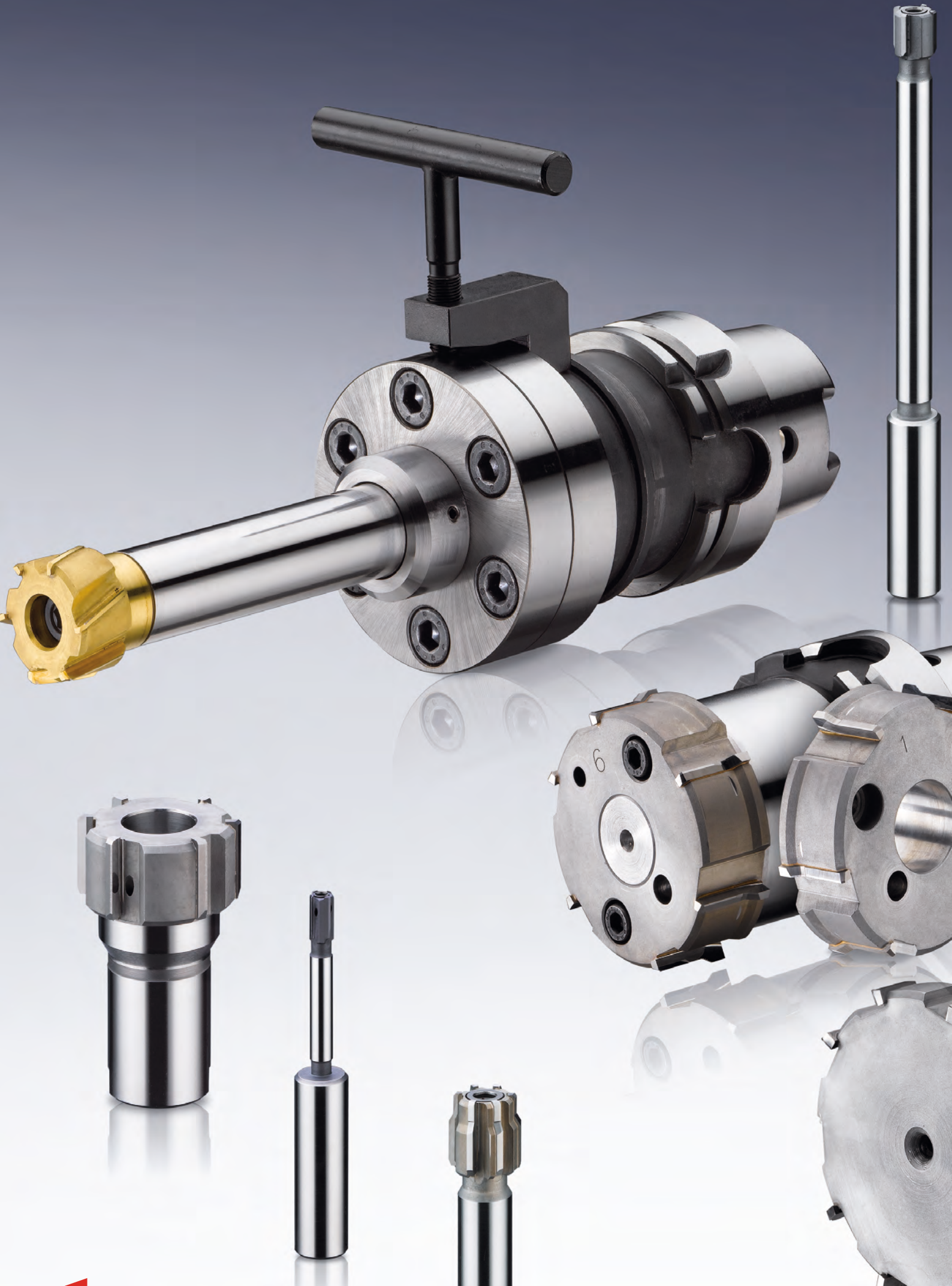

PORTE-OUTILS DE COMPENSATION & PORTE-OUTILS
AUSGLEICHSHALTER & HALTER
MANDRINI DI COMPENSAZIONE & PORTAUTENSILI



PORTE-OUTILS HYDRAULIQUES
HYDRO-DEHNSPANNFUTTER
MANDRINI ESPANDIBILI IDRAULICI

53



ADAPTATEURS POUR MACHINES
ADAPTER FÜR MASCHINEN
ADATTATORI PER MACCHINE

56

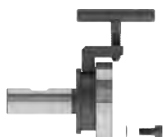

ADAPTATEURS INTERMÉDIAIRES
ZWISCHEN-ADAPTER
ADATTATORI INTERMEDI

58



ADAPTATEURS POUR OUTILS
ADAPTER FÜR WERKZEUGE
ADATTATORI PER UTENSILI

59



ADAPTATEURS POUR PINCES ER
ADAPTER FÜR ER-SPANNZANGEN
ADATTATORI PER PINZE ER

60



ADAPTATEURS POUR TÊTES
ADAPTER FÜR KÖPFE
ADATTATORI PER TESTINE

61

PORTE-OUTILS & ADAPTATEURS
 HALTER & ADAPTER
 PORTAUTENSILI & ADATTATORI

POLY 8154-HSK A



POLY 8154-ISO SK



POLY 8154-BT

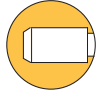

POLY 8254-HSK A

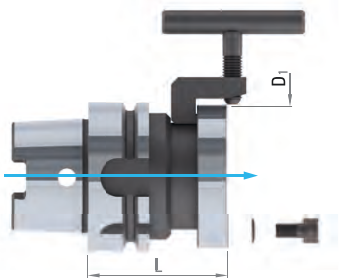

POLY 8354-ISO-SK

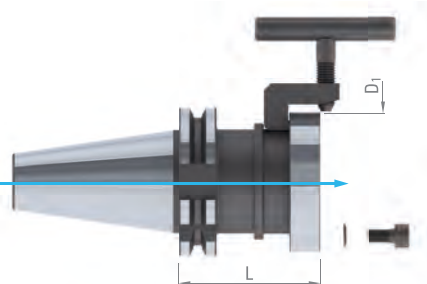

POLY 8354 BT

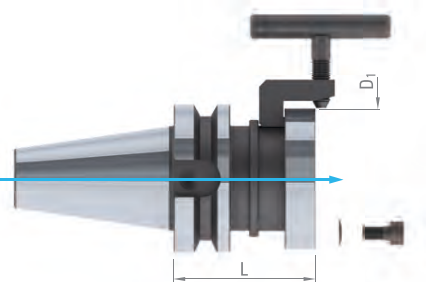

POLY 8054-DIN 1835 B

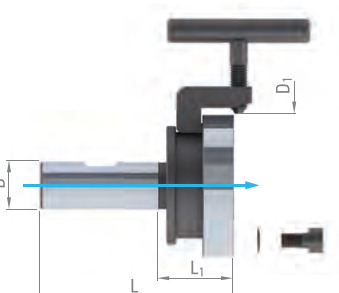

POLY 8524-DIN 1835 B

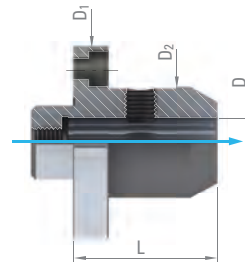

POLY 8524-ER

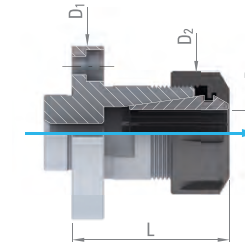

POLY 8502

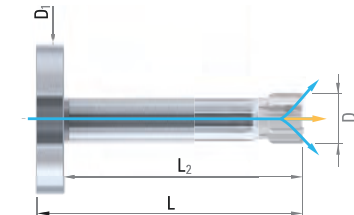

POLY 8154-HSK A

PORTE-OUTILS HYDRAULIQUES
 HYDRO-DEHNSPANNFUTTER
 MANDRINI ESPANDIBILI IDRAULICI

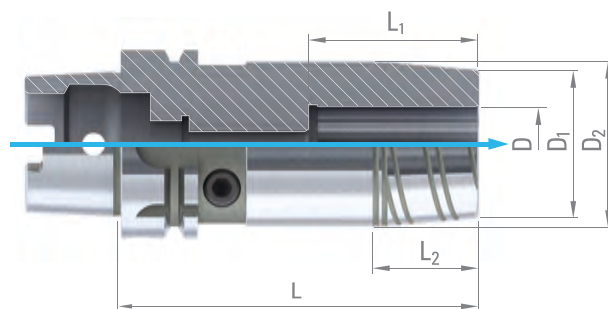

HSK A DIN 69893	D	L	L ₁	L ₂	D ₁	D ₂	Art.
40	12	80	46	-	32.0	34	345933
50	12	85	46	40	32.0	40	345934
50	16	90	49	46	38.0	42	345935
50	20	90	51	64	42.0	42	345936
63	12	85	46	40	32.0	50	345937
63	16	90	49	46	38.0	50	345938
63	20	90	51	46	42.0	50	345939
63	25	120	57	46	49.5	55	345940
63	32	125	61	99	56.0	63	345941
100	12	95	46	40	32.0	50	345942
100	16	100	49	46	38.0	50	345943
100	20	105	51	46	42.0	50	345944
100	25	115	57	86	49.5	55	345945
100	32	120	61	91	63.0	70	345946

POLY 8154-ISO SK

PORTE-OUTILS HYDRAULIQUES
 HYDRO-DEHNSPANNFUTTER
 MANDRINI ESPANDIBILI IDRAULICI

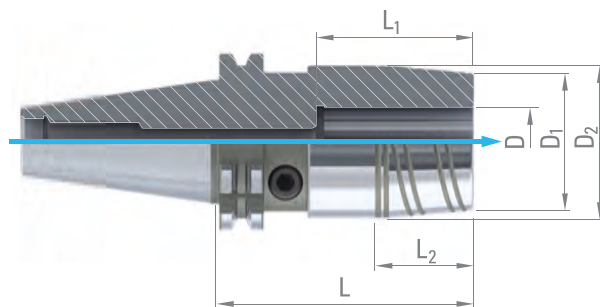

ISO-SK DIN 69871 AD	D	L	L ₁	L ₂	D ₁	D ₂	Art.
30	12	90	46	36	32.0	49.5	345947
30	20	100	57	46	42.0	49.5	345948
40	12	80	46	40	32.0	49.5	345949
40	16	80	49	46	38.0	49.5	345950
40	20	80	57	46	42.0	49.5	345951
40	25	95	57	76	49.5	55.0	345952
40	32	95	57	76	56.0	63.0	345953
50	12	80	46	40	32.0	49.5	345954
50	16	80	49	46	38.0	49.5	345955
50	20	80	57	46	42.0	49.5	345956
50	25	100	57	55	55.0	60.0	345957
50	32	100	57	55	63.0	70.0	345958

POLY 8154-BT

PORTE-OUTILS HYDRAULIQUES
 HYDRO-DEHNSPANNFUTTER
 MANDRINI ESPANDIBILI IDRAULICI

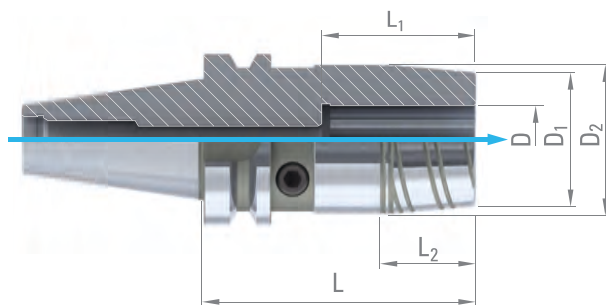

MAS-BT JIS B 6339	D	L	L ₁	L ₂	D ₁	D ₂	Art.
30	12	85	46	44.5	26.5	46	345959
30	20	90	51	44.5	36.0	40	345960
40	12	90	46	49.5	32.0	40	345961
40	16	90	49	49.5	38.0	46	345962
40	20	90	51	49.5	42.0	46	345963
40	25	90	57	55.0	49.5	63	345964
40	32	90	61	63.0	56.0	63	345965
50	12	110	46	49.5	32.0	40	345966
50	16	110	49	49.5	38.0	46	345967
50	20	110	51	49.5	42.0	46	345968
50	25	110	57	60.0	55.0	55	345969
50	32	115	61	70.0	63.0	55	345970

POLY 8254-HSK A

ADAPTATEURS POUR MACHINES
 ADAPTER FÜR MASCHINEN
 ADATTATORI PER MACCHINE



P. 72

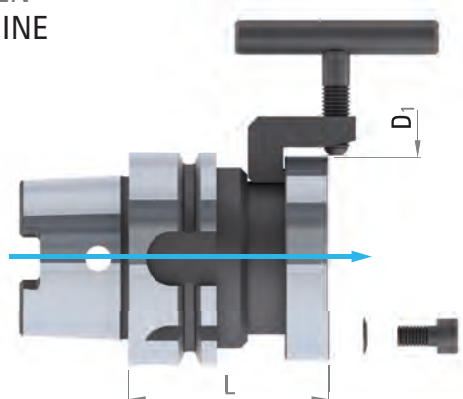

HSK A DIN 69893	D ₁	L	Art.
32	40	56	400922
40	40	58	401270
50	40	65	401271
63	40	65	401272
80	40	65	401273
100	40	68	401274
40	60	63	400923
50	50	70	400924
63	63	59	401285
80	80	70	401276
100	100	73	401277
50	50	74	400925
63	63	74	400926
80	80	74	401278
100	100	77	401279

Livré avec clé de réglage, vis de fixation et rondelles
 Lieferung mit Einstellschlüssel, Spannschrauben und Scheiben
 Consegnato con chiave di registrazione, viti di fissaggio e rondelle



POLY 8354-ISO SK

ADAPTATEURS POUR MACHINES
ADAPTER FÜR MASCHINEN
ADATTATORI PER MACCHINE



P. 72

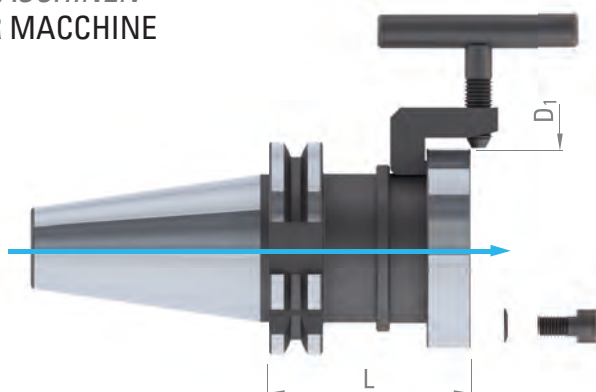

ISO-SK DIN 69871 AD	D ₁	L	Art.
40	40	58.0	400927
50	40	60.5	400928
40	60	63.0	400929
50	60	65.5	400930
40	71	67.0	400931
50	71	69.5	400932

POLY 8354-BT

ADAPTATEURS POUR MACHINES
ADAPTER FÜR MASCHINEN
ADATTATORI PER MACCHINE



P. 72

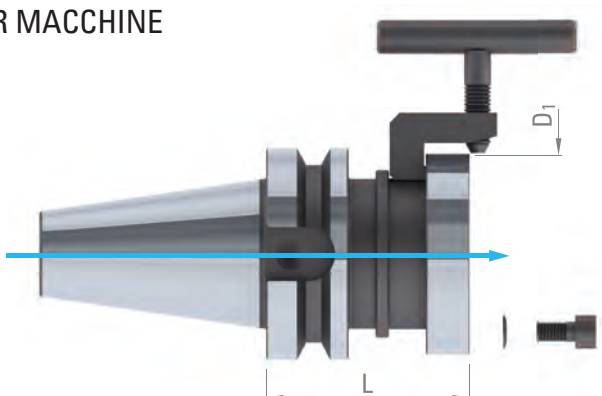

MAS-BT JIS B 6339	D ₁	L	Art.
40	60	53	64938
30	71	48	61490
40	71	65	61491
50	71	70	951465

Livré avec clé de réglage, vis de fixation et rondelles
Lieferung mit Einstellschlüssel, Spannschrauben und Scheiben
Consegnato con chiave di registrazione, viti di fissaggio e rondelle

POLY 8054-DIN 1835 B

ADAPTATEURS INTERMÉDIAIRES
 ZWISCHEN-ADAPTER
 ADATTATORI INTERMEDI



P. 72

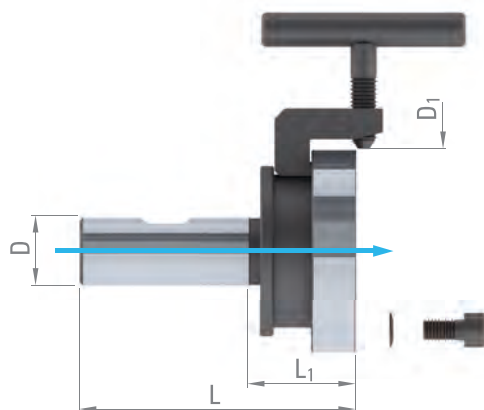

D_1	D_{h6}	L_1	L	Art.
40	12	21	68	400346
40	16	23	71	400347
60	20	28	81	400920
60	25	28	87	400921
71	20	34	90	400348
71	25	36	96	400349
71	32	37	100	400984
106	40	38	111	400351

Livré avec clé de réglage, vis de fixation et rondelles
 Lieferung mit Einstellschlüssel, Spannschrauben und Scheiben
 Consegnato con chiave di registrazione, viti di fissaggio e rondelle



POLY 8524-DIN 1835 B

ADAPTATEURS POUR OUTILS
 ADAPTER FÜR WERKZEUGE
 ADATTATORI PER UTENSILI



P. 72

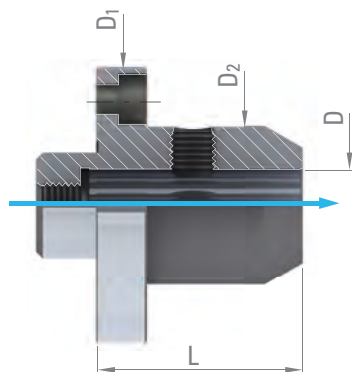

D_1	D_{h6}	D_2	L	Art.
40	8	20.0	42	400417
40	10	20.0	46	400418
60	10	30.0	36	400933
60	12	32.0	42	400934
60	16	34.5	45	400935
71	12	32.0	42	400419
71	16	35.0	44	400420
71	20	40.0	46	400421
71	25	50.0	70	400422
71	32	50.0	73	951431
106	32	64.0	77	951431

Livré avec vis de fixation et rondelles
 Lieferung mit Spannschrauben und Scheiben
 Consegnato con viti di fissaggio e rondelle



POLY 8524-ER

ADAPTATEURS POUR PINCES
 ADAPTER FÜR SPANNZANGEN
 ADATTATORI PER PINZE



P. 72

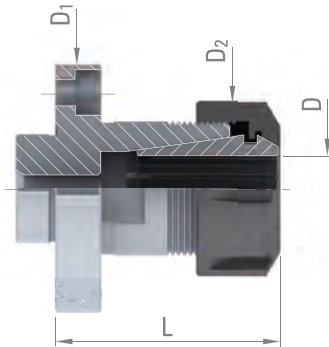

D ₁	ER	D	D ₂	L	Art.
40	16	1 - 10	22	40	400936
60	25	1 - 16	42	52	400938
71	32	2 - 20	50	63	400940

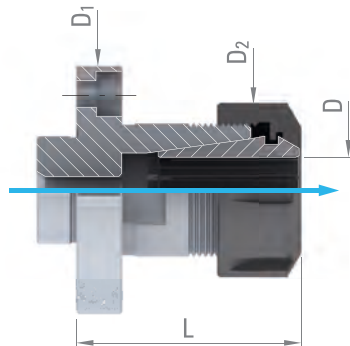

D ₁	ER	D	D ₂	L	Art.
40	16	1 - 10	22	44.0	400937
60	25	1 - 16	42	57.0	400939
71	32	2 - 20	50	65.5	400941

Avec écrou pour arrosage central, livré sans rondelle d'étanchéité
 Mit Mutter für Innenkühlung, Lieferung ohne Dichtscheibe
 Con dado per refrigerazione interna, consegnato senza rondella ermetica

Livré sans pince
 Lieferung ohne Spannzange
 Consegnato senza pinza



ADAPTATEURS POUR TÊTES
 ADAPTER FÜR KÖPFE
 ADATTATORI PER TESTINE



P. 72

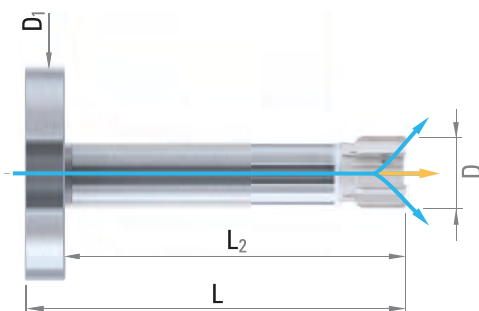

D	D ₁	L	L ₂	Art.
9.600 - 12.609	40	69	45	401222
12.610 - 15.609	40	84	60	401223
15.610 - 18.609	60	86	60	401224
18.610 - 23.109	160	106	80	401225
23.110 - 31.109	71	129	100	401226
31.110 - 45.000	71	134	105	401227
9.600 - 12.609	71	119	90	401228
12.610 - 15.609	71	129	100	401229
15.610 - 18.609	71	149	120	401230
18.610 - 23.109	71	169	140	401231
23.110 - 31.109	71	179	150	401232
31.110 - 45.000	71	179	150	401233

Commander tête & vis d'expansion ou de fixation séparément (page 42-46)

Kopf & Nachstellschraube oder Befestigungsschraube separat bestellen (Seite 42-46)

Ordinare testina & vite d'espansione o di fissaggio separatamente (pagine 42-46)



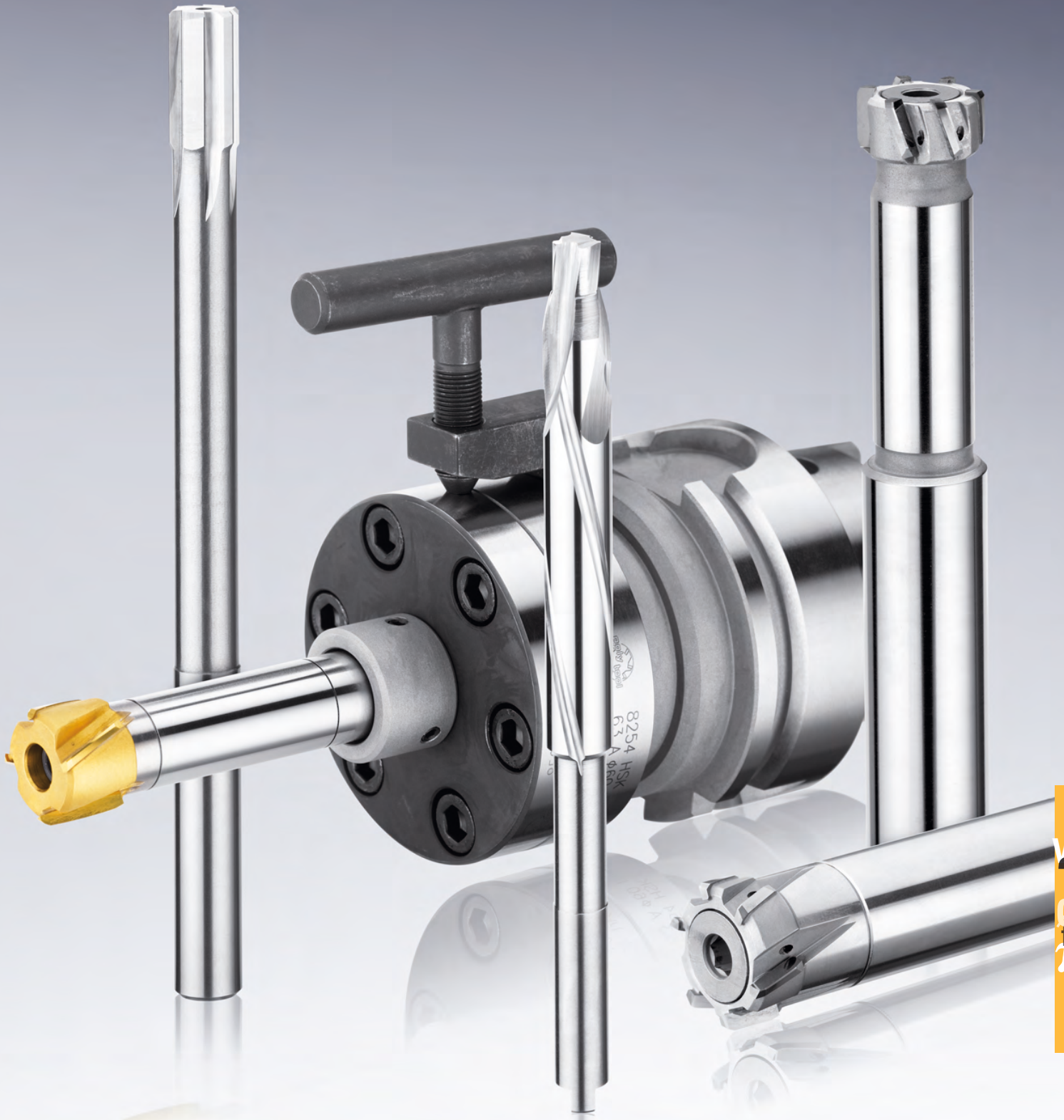

Ver
? 0
12
f



CONDITIONS DE COUPE
SCHNITTDATEN
CONDIZIONI DI LAVORAZIONE



ALÉSOIRS EN CARBURE MONOBLOC
VHM-REIBAHLEN
ALESATORI IN METALLO DURO INTEGRALE

64



ALÉSOIRS & TÊTES
REIBAHLEN & KÖPFE
ALESATORI & TESTINE

66

CONDITIONS DE COUPE ALÉSOIRS EN CARBURE MONOBLOC

SCHNITTDATEN VHM-REIBAHLEN

CONDIZIONI DI LAVORAZIONE ALESATORI IN METALLO DURO INTEGRALE



Vitesse de coupe
Schnittgeschwindigkeit **Vc [m/min]**
Velocità di taglio

Matières à usiner

Zu bearbeitender Werkstoff

Materiale da lavorare

		HM
P	Acier non allié / faiblement allié <i>Niedrig leg. / unleg. Stahl</i>	14
	Acciaio non legato / leggermente legato	16
P	Acier non allié / faiblement allié <i>Niedrig leg. / unleg. Stahl</i>	12
	Acciaio non legato / leggermente legato	14
P	Acier de décolletage au plomb <i>Bleilegiertes Automatenstahl</i>	25
	Acciaio al piombo	50
P	Acier fortement allié <i>Hochlegierter Stahl</i>	8
	Acciaio fortemente legato	10
M	Acier inoxydable <i>Rostfreier Stahl</i>	12
	Acciai inossidabili	16
M	Acier inox. DUPLEX, acier austénitique inox. sans nickel <i>DUPLEX rostfreier Stahl</i>	8
	Acciaio inox DUPLEX, acciaio inox austenitico senza Ni	10
K	Fonte grise / Fonte à graphite sphéroïdal perlitique <i>Grauguss / Sphäroguss perlitisch</i>	20
	Ghisa grigia / Ghisa perlitica sferoidale	30
K	Fonte allié / Fonte à graphite sphéroïdal perlitique <i>Leg. Grauguss / Sphäroguss perlitisch</i>	12
	Ghisa / Ghisa perlitica sferoidale	18
K	Fonte à graphite sphéroïdal ferritique / Fonte malléable <i>Sphäroguss ferritisch / Temperguss</i>	24
	Ghisa ferritica sferoidale / Ghisa malleabile	14
S	Super alliages / Acier inox. réfractaire <i>Sonderlegierungen / Warmfester rostfreier Stahl</i>	32
	Leghe speciali / Acciaio inox refrattario	8
S	Titane, alliage de titane <i>Titan, Titanlegierung</i>	10
	Titanio e relative leghe	12
N	Alliage de cuivre / bonne usinabilité (laiton – bronze) <i>Kupfer-Legierung / gut zerspanbar (Messing – Bronze)</i>	16
	Rame e relative leghe / facili da lavorare (ottone – bronzo)	30
N	Alliage de cuivre / usinabilité difficile / Bronze à l'aluminium <i>Kupfer-Legierung / schwer zerspanbar / Aluminium-Bronze</i>	16
	Rame e lega / difficili da lavorare / Bronzo con alluminio	24
N	Alliage d'aluminium <i>Aluminium-Knetlegierung</i>	30
	Leghe d'alluminio	20
N	Fonte d'aluminium <i>Aluminium-Gusslegierung</i>	40
	Fusioni d'alluminio	60
N	Plastique <i>Kunststoff</i>	20
	Plastica	40
N	Plastique avec fibres <i>Kunststoff mit Füllstoff</i>	60
	Plastica rinforzata	10
N	Or, argent <i>Gold, Silber</i>	20
	Oro, argento	30
		40

$$n \text{ [tr/min]} = \frac{V_c \text{ [m/min]} \times 1000}{\pi \times D_1 \text{ [mm]}}$$

$$V_f \text{ [mm/min]} = n \text{ [tr/min]} \times f \text{ [mm]}$$

Avance par tour
 Vorschub pro Umdrehung **f [mm]**
 Avanzamento al giro

Ø D ₁ < 2.00	Ø D ₁ 2.00 - 4.03	Ø D ₁ 4.03 - 7.51	Ø D ₁ 7.51 - 12.02
0.05	0.10	0.30	0.40
0.15	0.20	0.50	0.60
0.20	0.30	0.70	0.80
0.05	0.10	0.25	0.30
0.15	0.20	0.40	0.50
0.20	0.30	0.65	0.70
0.05	0.20	0.40	0.60
0.15	0.40	0.60	0.80
0.20	0.50	0.80	1.00
0.05	0.10	0.20	0.30
0.15	0.15	0.30	0.40
0.20	0.25	0.40	0.50
0.05	0.10	0.20	0.30
0.15	0.15	0.30	0.40
0.20	0.20	0.40	0.50
0.05	0.10	0.20	0.30
0.15	0.15	0.30	0.40
0.20	0.25	0.40	0.50
0.05	0.10	0.40	0.60
0.15	0.15	0.50	0.70
0.20	0.25	0.60	0.80
0.05	0.10	0.30	0.40
0.15	0.15	0.40	0.50
0.20	0.20	0.50	0.60
0.05	0.10	0.30	0.40
0.15	0.20	0.40	0.50
0.20	0.30	0.50	0.60
0.05	0.10	0.20	0.30
0.15	0.15	0.30	0.40
0.20	0.20	0.40	0.50
0.05	0.10	0.20	0.30
0.15	0.15	0.30	0.40
0.20	0.20	0.40	0.50
0.05	0.10	0.30	0.40
0.15	0.20	0.40	0.50
0.20	0.30	0.50	0.60
0.05	0.10	0.40	0.60
0.20	0.25	0.60	0.80
0.30	0.40	0.80	1.00
0.05	0.10	0.40	0.60
0.20	0.25	0.60	0.80
0.30	0.40	0.80	1.00
0.05	0.10	0.40	0.50
0.20	0.25	0.50	0.60
0.30	0.40	0.60	0.70
0.05	0.10	0.30	0.40
0.20	0.25	0.40	0.50
0.30	0.40	0.50	0.60
0.05	0.10	0.40	0.60
0.15	0.20	0.60	0.80
0.20	0.30	0.80	1.00

0.05	0.10	0.10	0.10	Surépaisseur	Ø [mm]
0.10	0.15	0.15	0.15	Reibzugabe	
0.15	0.20	0.20	0.20	Sovrametallo	



CONDITIONS DE COUPE ALÉSOIRS & TÊTES
 SCHNITTDATEN GELÖTETE REIBAHLEN & KÖPFE
 CONDIZIONI DI LAVORAZIONE ALESATORI & TESTINE



Matières à usiner

Zu bearbeitender Werkstoff

Materiale da lavorare		DIN	W. Nr.	Rm	HB / HRC
P	Acier non allié / faiblement allié <i>Niedrig leg. / unleg. Stahl</i> Acciaio non legato / leggermente legato	St37-2 / S235JR	1.0037	< 600 N/mm ²	
		9SMn28 / 11SMn30	1.0715		
		St52-2 / E295	1.0050		
		9SMnPb28 / 11SMnPb30	1.0718		
P	Acier non allié / faiblement allié <i>Niedrig leg. / unleg. Stahl</i> Acciaio non legato / leggermente legato	42CrMo4	1.7225	600 – 1500 N/mm ²	
		CK60 / C60E	1.1221		
P	Acier fortement allié <i>Hochlegierter Stahl</i> Acciaio fortemente legato	X6CrMo4 / 6CrMo15-5	1.2341	700 – 1500 N/mm ²	
		X165Cr-MoV12	1.2601		
M	Acier inoxydable <i>Rostfreier Stahl</i> Acciaio inossidabili	X2CrNi189 / X2CrNi19-11	1.4306	400 – 700 N/mm ²	
		Mo1810 / X5CrNiMo17-12-2	1.4401		
		X2CrNiMo18-14-3 / 316L	1.4435		
		X8CrNb17 / X3CrNb17	1.4511		
M	Acier inox. DUPLEX, acier austénitique inox. sans nickel <i>DUPLEX rostfreier Stahl</i> Acciaio inox DUPLEX, acciaio inox austenitico senza Ni	X10CrAIS17	1.4713	> 800 N/mm ²	
		X8CrS-38-18	1.4862		
H	Acier trempé <i>Gehärtete Stähle</i> Acciaio temprato			> 1500 N/mm ²	45 - 65 HRC
K	Fonte grise <i>Grauguss</i> Ghisa grigia	GG-25 / EN-GJL-250	0.6025		< 250 HB
		GG-35 / EN-GJL-350	0.6035		
K	Fonte grise allié <i>Leg. Grauguss</i> Lega di ghisa grigia	GG-NiCr202 / GJL-NiCr20-2	0.6660		> 250 HB
K	Fonte à graphite sphéroïdal ferritique / perlitique <i>Sphäroguss ferritisch / perlitisch</i> Ghisa ferritica sferoidale / perlitica	GGG-40 / EN-GJS-400-15	0.7040		< 600 HB
		GGG-50 / GGG-55	0.7050		
		GTW-55	0.8055		
K	Fonte à graphite sphéroïdal ferritique / Fonte malléable <i>Sphäroguss ferritisch / Temperguss</i> Ghisa perlitica sferoidale / Ghisa malleabile	GGG-60 / EN-GJS-600-3	0.7060		> 600 HB
		GTS-65	0.8165		
K	Alliages fonte sphéroïdale <i>Leg. Sphäroguss</i> Leghe di ghisa sferoidale	GGG NiCr20-2	0.7661		
		GGV Ti <0.2			
		GGV Ti >0.2			
S	Super alliages / Acier inox. réfractaire <i>Sonderlegierungen / Warmfester rostfreier Stahl</i> Leghe speciali / Acciaio inox refrattario	Inconel		> 1500 N/mm ²	
		Nimonic Hastelloy			
S	Titane, alliage de titane <i>Titan, Titanlegierung</i> Titanio e relative leghe	TiAl55n2	3.7114		
N	Alliage de cuivre (laiton - bronze) <i>Kupfer-Legierung (Messing - Bronze)</i> Rame e relative leghe (ottone - bronzo)	CuZn36Pb3	2.1182		
		G-CuPb15Sn	2.1182		
N	Alliage de cuivre / Bronze à l'aluminium <i>Kupfer-Legierung / Aluminium-Bronze</i> Rame e lega / Bronzo con alluminio	CuZn40Al1	2.0550		
		E-Cu57	2.0060		
N	Alliage d'aluminium <8 % Si / Alliage de magnesium <i>Aluminium-Knetlegierung <8 % Si / Magnesiumlegierungen</i> Leghe d'alluminio <8 % Si / Leghe di magnesio	G-AIMg5	3.3561		
N	Alliage d'aluminium >8 % Si <i>Aluminium-Knetlegierung >8 % Si</i> Leghe d'alluminio >8 % Si	G-AISi9Mg	3.2373		
		G-AISi10Mg	3.2381		

$$n \text{ [tr/min]} = \frac{Vc \text{ [m/min]} \times 1000}{\pi \times D_1 \text{ [mm]}}$$

$$Vf \text{ [mm/min]} = n \text{ [tr/min]} \times f \text{ [mm]}$$

						f [mm]			
HM	TiAIN	POLYCUT	C-TOP	DLC	CERMET	Ø D ₁ 5.80 - 10.60	Ø D ₁ 10.70 - 18.60	Ø D ₁ 18.70 - 44.90	Ø D ₁ 45 - 120
25	60	60			100	0.20	0.40	0.60	0.80
30	90	90			130	0.30	0.50	0.70	0.90
35	120	120			150	0.50	0.70	0.90	1.10
20	60	60	30		80	0.20	0.40	0.60	0.80
25	80	80	40		100	0.30	0.50	0.70	0.90
30	100	100	50		120	0.50	0.70	0.90	1.10
15	30	30	30			0.15	0.25	0.35	0.45
20	40	40	40			0.20	0.30	0.40	0.50
25	50	50	50			0.30	0.40	0.50	0.60
15	30	30	30			0.20	0.30	0.40	0.50
20	40	40	40			0.30	0.40	0.50	0.60
25	50	50	50			0.40	0.50	0.60	0.70
10	30	30	30			0.20	0.30	0.40	0.50
15	40	40	40			0.30	0.40	0.50	0.60
20	50	50	50			0.40	0.50	0.60	0.70
			10			0.10	0.15	0.20	0.25
			15			0.15	0.20	0.25	0.30
			20			0.20	0.25	0.30	0.35
20	90	90				0.30	0.50	0.70	0.90
30	120	120				0.40	0.60	0.80	1.00
40	140	140				0.50	0.70	0.90	1.10
12	90	90				0.20	0.40	0.60	0.80
18	120	120				0.30	0.50	0.70	0.90
24	140	140				0.50	0.70	0.90	1.10
12	90	90			110	0.30	0.50	0.70	0.90
18	120	120			140	0.40	0.60	0.80	1.00
24	140	140			160	0.50	0.70	0.90	1.10
14	90	90			100	0.20	0.40	0.60	0.80
20	120	120			120	0.30	0.50	0.70	0.90
32	140	140			140	0.40	0.60	0.80	1.00
12	50	50				0.20	0.30	0.40	0.50
18	60	60				0.30	0.40	0.50	0.60
24	80	80				0.40	0.50	0.60	0.70
	10	10				0.15	0.20	0.30	0.45
	15	15				0.20	0.25	0.35	0.50
	20	20				0.30	0.30	0.40	0.60
10						0.20	0.30	0.40	0.50
15						0.30	0.40	0.50	0.60
20						0.40	0.50	0.60	0.70
30	100	100		80		0.30	0.50	0.70	0.90
40	120	120		120		0.40	0.60	0.80	1.00
50	150	150		160		0.50	0.70	0.90	1.10
25	60	60		80		0.20	0.40	0.60	0.80
30	80	80		120		0.30	0.50	0.70	0.90
35	100	100		160		0.40	0.60	0.80	1.00
30				250		0.30	0.50	0.70	0.90
50				200		0.40	0.60	0.80	1.00
70				300		0.50	0.70	0.90	1.10
30				150		0.30	0.50	0.70	0.90
40				200		0.40	0.60	0.80	1.00
50				300		0.50	0.70	0.90	1.10

0.10	0.15	0.15	0.20
0.15	0.20	0.20	0.30
0.20	0.30	0.30	0.40





INFORMATIONS GÉNÉRALES
ALLGEMEINE INFORMATIONEN
INFORMAZIONI GENERALI



REGARNISSAGE
NEUBESTÜCKUNG
RIGENERAZIONE

71



PORTE-OUTIL DE COMPENSATION RADIALE
RADIAL-AUSGLEICHSHALTER
MANDRINO DI COMPENSAZIONE RADIALE

72



TECHNOLOGIE SYSTÈME EXPANSIBLE
NACHSTELL SYSTEM-TECHNOLOGIE
TECNOLOGIA DEL SISTEMA ESPANDIBILE

73

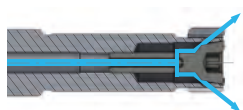

TECHNOLOGIE D'ARROSSAGE
KÜHLSYSTEM TECHNOLOGIE
TECNOLOGIA DI REFRIGERAZIONE

74



TECHNOLOGIE ALÉSOIRS AVEC GUIDES
FÜHRUNGSREIBAHLEN-TECHNOLOGIE
TECNOLOGIA DEGLI ALESATORI CON GUIDA

75



GÉOMÉTRIE DE COUPE
ANSCHNITT GEOMETRIE
GEOMETRIA IMBOCCO

76



616

531-385754N



REGARNISSAGE
NEUBESTÜCKUNG
RIGENERAZIONE

Regarnissage

Selon l'usure de l'outil, le centre de réaffûtage de DIXI Polytool propose un changement complet des inserts.
Le regarnissage est possible avec des plaquettes en CARBURE et CERMET.

Le regarnissage est assuré pour les outils de tous fabricants.

Neubestückung

Je nach Verschleiß des Werkzeuges bietet Ihnen unser Nachschärfzentrum bei DIXI Polytool einen Nachschliff oder einen kompletten Austausch der Schneiden.

Dies ist möglich bei HARTMETALL und CERMET.

Wir bieten Neubestückung für Werkzeuge aller Hersteller an.

Rigenerazione

A seconda dell'usura dell'utensile, il centro di riaffilatura DIXI Polytool offre la sostituzione completa dei taglienti.
La riaffilatura è possibile con i taglienti in METALLO DURO e CERMET.

DIXI Polytool effettua la rigenerazione su alesatori di qualsiasi marca.

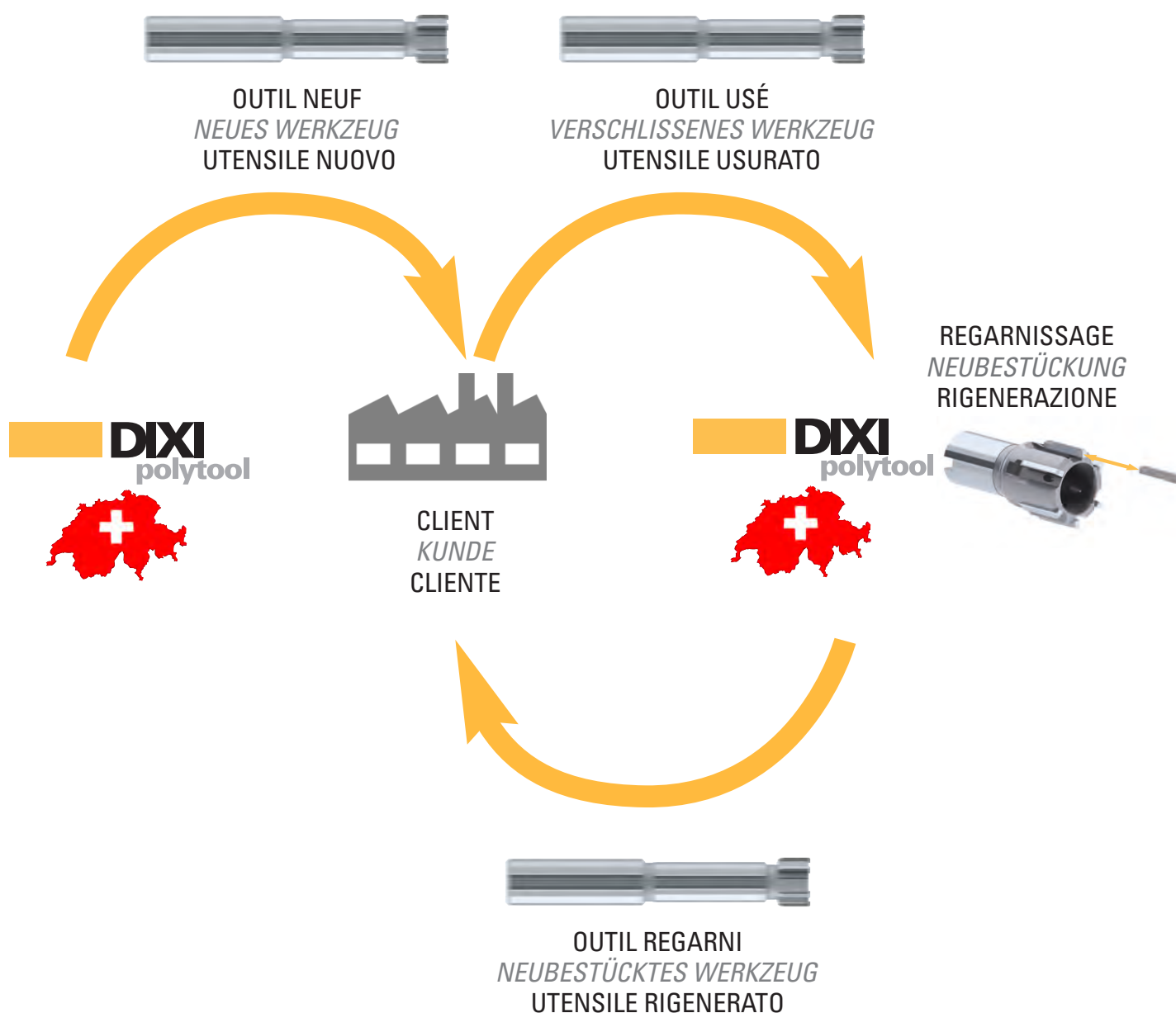

PORTE-OUTIL DE COMPENSATION RADIALE
RADIAL-AUSGLEICHSHALTER
MANDRINO DI COMPENSAZIONE RADIALE



1. Monter l'alesoir (ou le foret, le foret à centrer, etc.) sur le porte-outil de compensation.
2. Monter le porte-outil sur la broche de la machine.
3. Desserrer les vis (2) et les mettre sous tension, l'une après l'autre (compression des rondelles ressorts).
4. Positionner le comparateur sur la partie rectifiée de l'outil à proximité de la denture (voir figure).
5. Insérer la clé de réglage (1) où l'erreur est maximale et tourner la clé jusqu'à ce que le comparateur indique la moitié de l'erreur. Desserrer la clé.
6. Contrôler la coaxialité. Au besoin, répéter la procédure. Si l'espace est suffisant, il n'est pas nécessaire d'enlever la clé, il est possible de la faire tourner dans la gorge.
7. Serrer en croix les vis (2).
8. Retirer la clé (1).

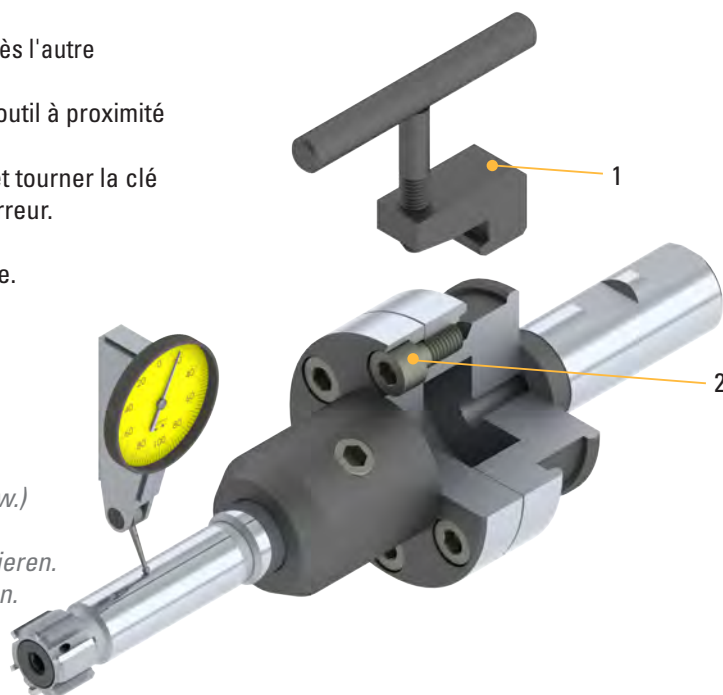

1. Die Reibahle (oder Senker, Bohrer, Zentrierbohrer, usw.) auf dem Ausgleichshalter montieren.
2. Den Ausgleichshalter auf die Maschinenspindel montieren.
3. Die Schrauben (2) nacheinander lösen und vorspannen.
4. Die Messuhr auf dem geschliffenen Teil des Werkzeuges hinter den Schneiden (siehe Bild) anbringen.
5. An der höchsten Stelle des Schlagfehlers den Schlüssel (1) einrasten und um die Hälfte des Schlagfehlers verschieben, Schlüssel (1) lösen.
6. Rundlauf kontrollieren. Falls nötig, Nachstellvorgang wiederholen. Sollte genügend Platz vorhanden sein, muß der Schlüssel für die Wiederholung der Nachstellung nicht abgenommen werden. Für die wiederholte Nachstellung kann der Schlüssel in der Aufnahmenute zur benötigten Position geführt werden.
7. Befestigungsschrauben (2) kreuzweise anziehen.
8. Schlüssel (1) entfernen.

1. Montare l'alesatore (o la punta, la punta a centrare, ecc.) sul mandrino di compensazione.
2. Montare il mandrino in macchina.
3. Liberare le viti (2) e metterle sotto tensione, l'una dopo l'altra (compressione delle rondelle molla).
4. Posizionare il comparatore sulla parte rettificata dell' utensile dietro i taglienti (vedi figura).
5. Inserire la chiave di registrazione (1) dove l'errore di coassialità è massimo, e chiuderla finchè il comparatore indichi la metà dell' errore. Liberare la chiave.
6. Controllare la coassialità. Se necessario, ripetere la procedura. Se lo spazio è sufficiente, non è necessario ritirare la chiave, è possibile girarla nella scanalatura.
7. Chiudere in croce le viti (2).
8. Ritirare la chiave (1).

SYSTÈME DE TOLÉRANCE
 TOLERANZ-SYSTEM
 SISTEMA DI TOLLERANZA

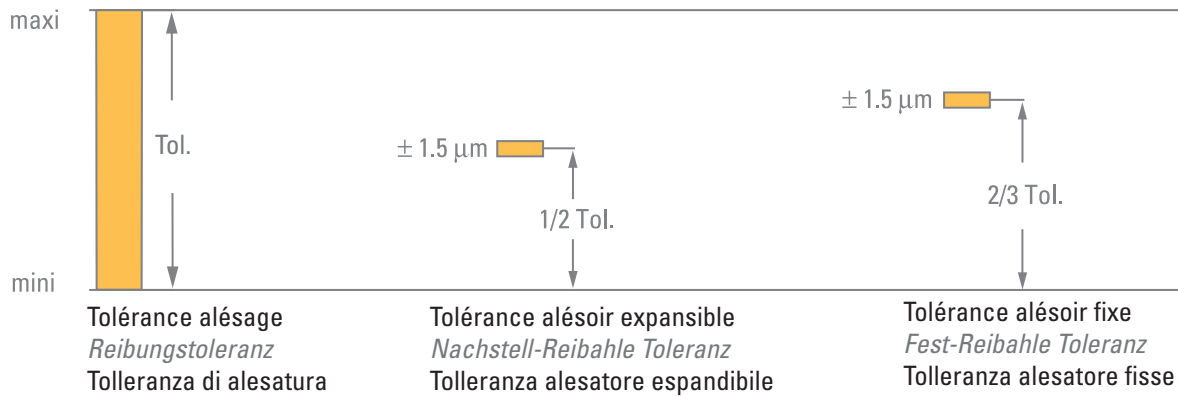

TECHNOLOGIE SYSTÈME EXPANSIBLE
 NACHSTELL SYSTEM-TECHNOLOGIE
 TECNOLOGIA DEL SISTEMA ESPANDIBILE

Réglage du $\varnothing D_1$ - zone d'élasticité \approx de $+10^\circ$ à $+40^\circ$
 Einstellen des $\varnothing D_1$ im elastischen Bereich \approx von $+10^\circ$ bis $+40^\circ$
 Registrazione del $\varnothing D_1$ - zona elastica \approx da $+10^\circ$ a $+40^\circ$

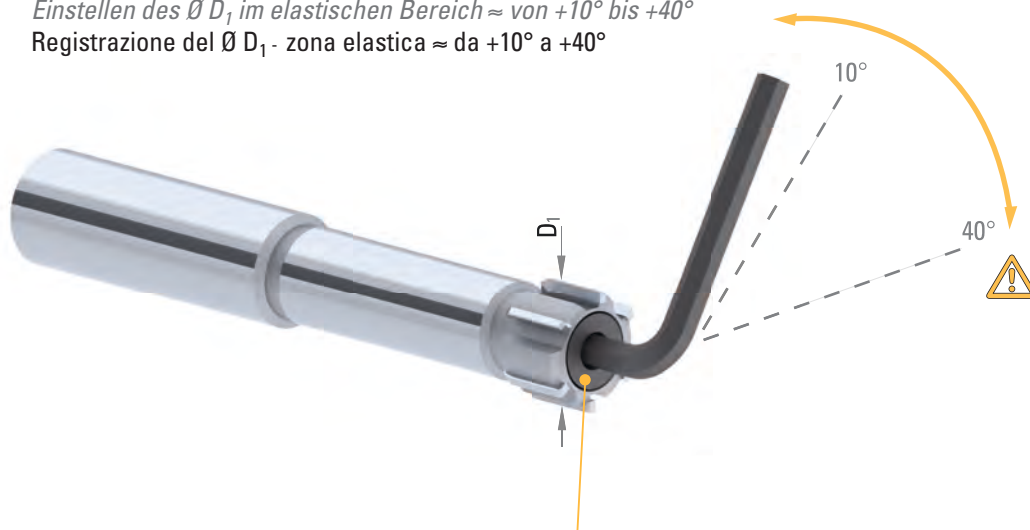

	D_1	Vis Schraube Vite	Expansion Aufweitung Espandibilità
Têtes	5.80 - 9.60	M ... x 0.35	$+10^\circ = D_1 + 0.0025$
Köpfe	9.61 - 21.10	M ... x 0.50	$+10^\circ = D_1 + 0.0035$
Testine	21.11 - 55.00	M ... x 0.75	$+10^\circ = D_1 + 0.0050$





Arrosage TC
Kühlsystem TC
Refrigerazione TC

POLY 4361-TC

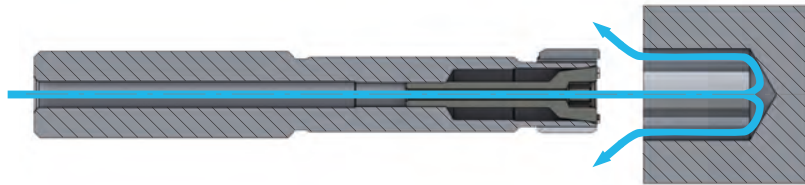

Avantages du système d'**arrosage TC** pour trous borgnes:

- Le retour du liquide entraîne les copeaux vers l'arrière
- Le trou est nettoyé avant l'opération d'alésage

Vorteile des **Kühlsystemes TC** für Sacklochbohrungen:

- Das vom Bohrungsgrund zurückfließende Kühlmittel spült die Späne beim Reibvorgang aus den Spanräumen und aus der Bohrung heraus
- Reinigung der Bohrungen vor dem Reibprozess

Vantaggi del sistema di **refrigerazione TC** per fori ciechi:

- Il ritorno del refrigerante espelle i trucioli indietro
- Il foro è pulito prima dell'operazione di alesatura

Arrosage FC
Kühlsystem FC
Refrigerazione FC

POLY 4361-FC

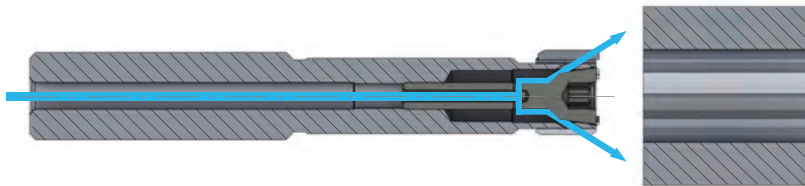

Avantages du système d'**arrosage FC** pour trous débouchants:

- Arrosage précis de l'arête de coupe

Vorteile des **Kühlsystemes FC** für Durchgangsbohrungen:

- Zielgerichtete Kühlung an der Schneiden.

Vantaggi del sistema di **refrigerazione FC** per fori passanti:

- Getto preciso sul tagliente



Fig.1

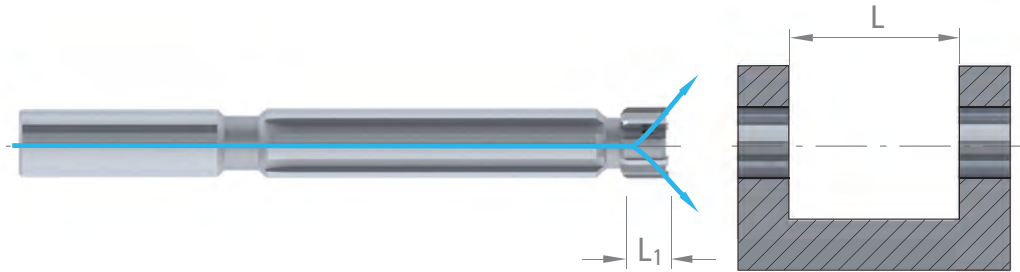

Fig.2

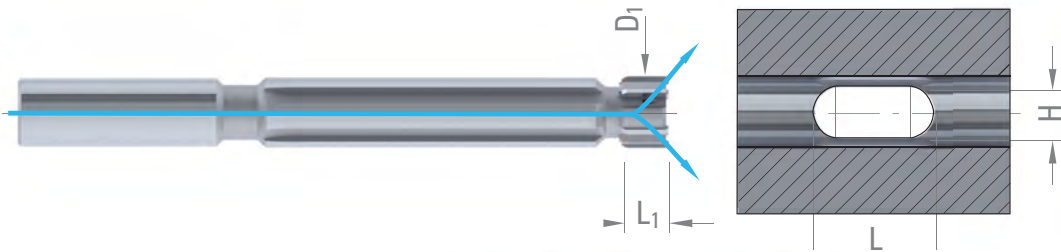
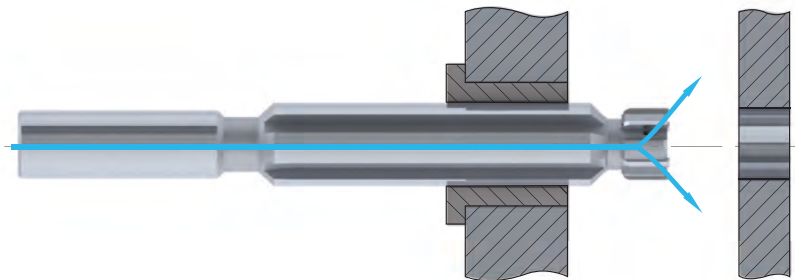

Fig.3



Applications des alésoirs avec guides

Ce type d'alésoir est utilisé dans trois cas.

Le diamètre de guidage est généralement 10 à 15 μm plus petit que le diamètre d'alésage.
L'arrosage doit être abondant pour évacuer les copeaux et lubrifier le guide.

Anwendungen von Führungsreibahlen

Dieser Reibahlen-Typ wird in folgenden Fällen eingesetzt.

Der Führungsdurchmesser der Reibahle ist in der Regel 10 bis 15 μm kleiner als das Ist-Maß der Reibahle.
Die Kühlschmierung muß ausreichend sein, um die Späne zu entfernen, bzw. die Führung zu schmieren.

Applicazioni degli alesatori con guida

Questo tipo di alesatore è usato in tre casi.

Il diametro della guida è generalmente 10 - 15 μm più piccolo del diametro di alesatura.
Il refrigerante deve essere abbondante per evacuare i trucioli e lubrificare la guida.



GÉOMÉTRIE DE COUPE
ANSCHNITT GEOMETRIE
GEOMETRIA IMBOCCO



Coupe standard 45°
Standardanschnitt 45°
Imbocco standard 45°

- ✓ Alésage standard
Standardanschnitt
Imbocco standard

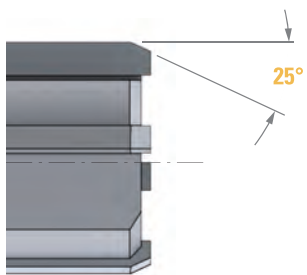

Coupe plate 25°
Flachanschnitt 25°
Imbocco piatto 25°

- ✓ Haute avance ($V_c ; f + 50\%$), durée de vie augmentée
Hoher Vorschub ($V_c ; f + 50\%$), erhöhte Lebensdauer
Elevata portata ($V_c ; f + 50\%$), maggiore utensile vita

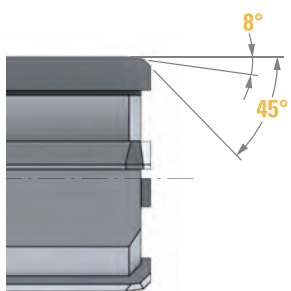

Double angle 45°/8°
Doppelanschnitt 45°/8°
Doppio angolo 45°/8°

- ✓ Meilleur état de surface
Bessere Oberflächengüte
Migliore finitura superficiale

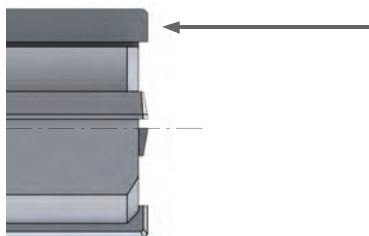

Coupe frontale
Stirnschnitt
Imbocco frontale

- ✓ Corrige la position alésoir/pièce
Reibahle/Stückpositionskorrektur
Errore di posizione alesatore/pezzo

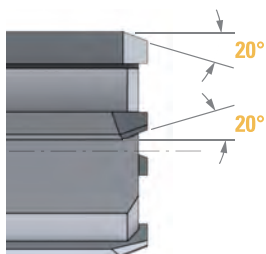

Coupe négative 20°/20°
Flachanschnitt 20°/20°
Imbocco piatto 20°/20°

- ✓ Evacuation du copeau en avant
Späneabfuhr nach vorne
Evacuazione del truciolo in avanti

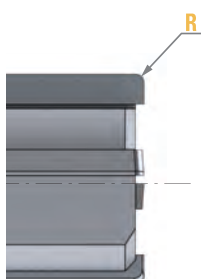

Coupe rayon
Radiusanschnitt
Imbocco raggio

- ✓ Géométrie de formes
Formgeometrie
Geometria della forma

DIXI POLYTOOL S.A.R.L
ZAC de Rubellin
FR-73730 Cevins
T +33 (0)4 79 38 25 92
F +33 (0)4 79 38 26 65
dixifrance@dixi.com

DIXI POLYTOOL GmbH
Carl-Benz-Str. 11
DE-75217 Birkenfeld
T +49 (0)7231-1 68 98-0
F +49 (0)7231-3 39 19
dixipolytool@dixi.com

DIXI POLYTOOL B.V.
De Hofstede 11
NL-4033 BT Lienden
T +31 (0)344-603410
F +31 (0)344-603488
dixiholland@dixi.com

DIXI POLYTOOL SPAIN S.L.
Bailen 141 Esc. Dr, Entl. 5a
ES-08037 Barcelona
T +34 678 917 351
dixispain@dixi.com

DIXI POLYTOOL S.A. / VENTURA MECANICS S.A.
Swiss Center Shanghai Machinery and Trading
and Business Center Room A208, Building 3, NO.
526, 3rd East Fute Road
200131 China (Shanghai) Pilot Free Trade Zone

polytool



MÉCANIQUE GÉNÉRALE
METALLBEARBEITUNG
MECCANICA GENERALE

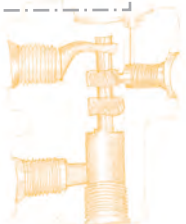

HYDRAULIQUE
HYDRAULISCH
IDRAULICO

AUTOMOBILE
AUTOMOTIVE
AUTOMOTIVE



AÉRONAUTIQUE
LUFTFAHRT
AERONAUTICO

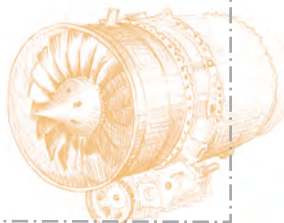

ÉNERGIE
ENERGIE
ENERGIA



DÉCOLLETAGE
DREHTECHNIK
TORNITURA



MICROMÉCANIQUE/ELECTRONIQUE
MIKROMECHANIK/ELEKTRONIK
MICROMECCANICA/ELETTRONICA

POIDS LOURD
LKW
CAMION



 **DIXI**
polytool

DIXI POLYTOOL S.A.

Av. du Technicum 37
CH-2400 Le Locle

T +41 (0)32 933 54 44

F +41 (0)32 931 89 16

dixipoly@dixi.ch

www.dixipolytool.com

